

Lensbar Square P5

P5 → 18 LED/m • 5 LED/ft
19,8 W/m • 6,0 W/ft

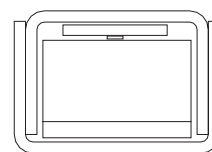
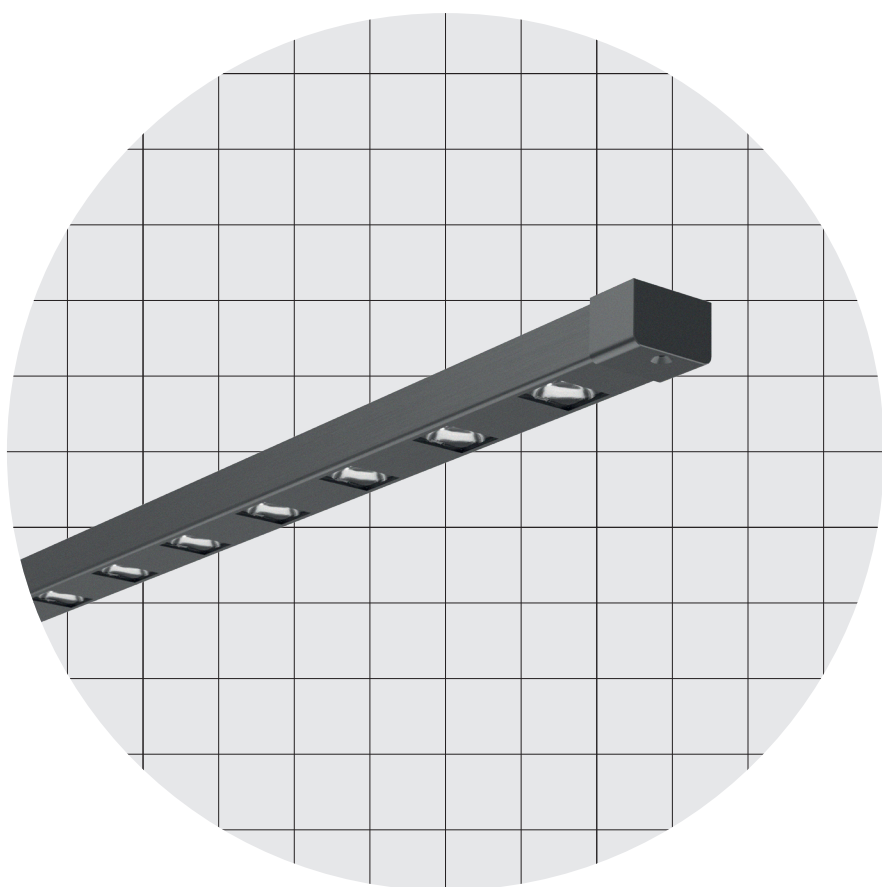

27,4 × 20,0 mm
1,08 × 0,79 "

Lensbar Square P5



Spotted

Body Corpo

Spot fixed on adjustable symmetrical linear profile

Spot fissi su profilo lineare simmetrico orientabile

Fastening Fissaggio	Heads with screws Fixed heads + Magnetic tape Adjustable heads with screws	Testatine con viti Testatine fisse + Nastro magnetico Testatine orientabili con viti
Optics Ottica	10° • 19° • 28° • 41° • Oval (37°+15°)	10° • 19° • 28° • 41° • Oval (37°+15°)
Wiring set Cavo alimentazione	2000 mm • 78,74 "	2000 mm
Custom size Lunghezza ordinabile	Up to 1960 mm • 77,17 " Up to 1500 mm • 59,06 " with heads	Fino a 1960 mm Fino a 1500 con testatine
Finishing Finitura	<ul style="list-style-type: none"> ● Grey anodized (Standard) → On request other finishes ● Anodica grigia (Standard) → Su richiesta altre finiture 	

Listings and marks

Certificazioni e marchi



Where we produce

Dove produciamo

Made in Italy

LED (See page CRI)

LED (Vedi pagina CRI)



Light Luce

Pitch Passo	↓ P5 55,5 mm • 2,19 "
Light source Sorgente luminosa	18 LED/m • 5 LED/ft
Power consumption Consumo energia	19,8 W/m • 6,0 W/ft
CCT K	<ul style="list-style-type: none"> ● 2700 K ● 3000 K ● 3500 K ● 4000 K ● 5000 K
On request/Su richiesta: ● Mixing/Miscelazione	
CRI R9 Rf @ 3000 K Rg @ 3000 K MacAdam ellipse	Min 90 Min 80 95 102 2
Delivered lumen output Flusso luminoso emesso ● 3000 K	↓ OVAL – 92 lm/W 1821 lm/m • 555 lm/ft
Input voltage Tensione di ingresso	24 V DC

Lensbar Square P5

Dimensions Dimensioni

Scale/Scala 1:2

TE Heads with screws
Testatine con viti

TEN Fixed heads + Magnetic tape (Thickness: 1,7 mm • 0,07 ")
Testatine fisse + Nastro magnetico (Spessore: 1,7 mm)

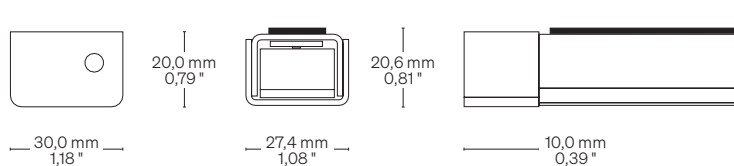

TO Adjustable heads with screws
Testatine orientabili con viti

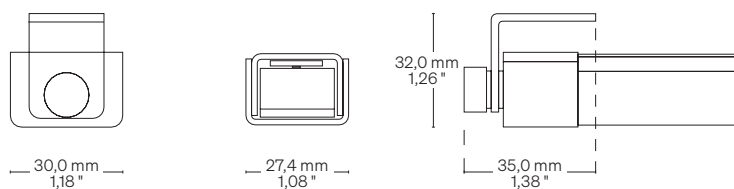
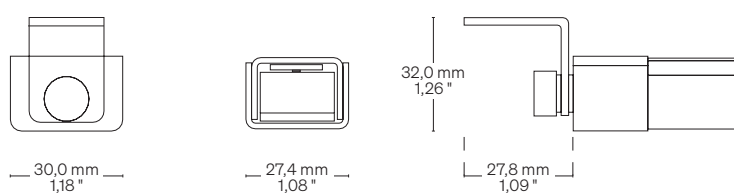

Fastening options Opzioni di fissaggio

TE Heads with screws
Testatine con viti

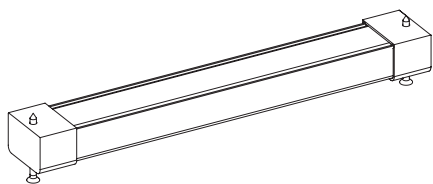

TEN Fixed heads + Magnetic tape (Thickness: 1,7 mm • 0,07 ")
Testatine fisse + Nastro magnetico (Spessore: 1,7 mm)

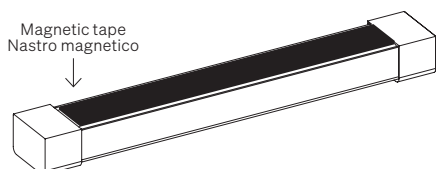

TO Adjustable heads with screws
Testatine orientabili con viti

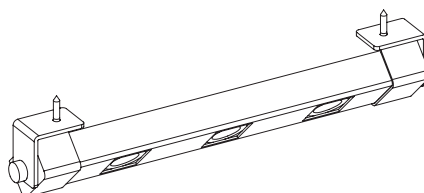

Lensbar Square P5

Order code Codice ordine	
Basic code Codice base	<ul style="list-style-type: none"> • BSA5 Lensbar Square P5 18 LED/m • 5 LED/ft 19,8 W/m • 6,0 W/ft
CCT K CCT K	<ul style="list-style-type: none"> • WW27 ● 2700 K • WW30 ● 3000 K • NW35 ● 3500 K • NW ● 4000 K • CW ● 5000 K
Fastening options Opzioni di fissaggio	<ul style="list-style-type: none"> • TE Heads with screws Testatine con viti • TEN Fixed heads + Magnetic tape Testatine fisse + Nastro magnetico • TO Adjustable heads with screws Testatine orientabili con viti
Optics Ottica	<ul style="list-style-type: none"> • 10 10° • 19 19° • 28 28° • 41 41° • OVAL Oval (37°+15°)
Ordering length Lunghezza ordinabile	<ul style="list-style-type: none"> • -- → Specify the custom size or visit formulaluci.com, for standard lenght. → Specificare la misura custom oppure visitare il sito formulaluci.com, per le lunghezze standard.
Order example Esempio ordine	<ul style="list-style-type: none"> • BSA5 WW27 TE 10 • 0,32 Lensbar Square P5, 18 LED/m • 5 LED/ft 19,8 W/m • 6,0 W/ft, Warm White 2700, Heads with screws, 10° Optic • 0,32 m Lensbar Square P5, 18 LED/m, 19,8 W/m, Warm White 2700, Testatine con viti, Ottica 10° • 0,32 m

CRI Typical* CRI Tipici*

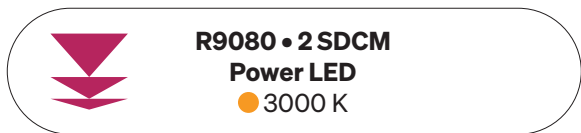

CRI: 97,4 (R1-R8)

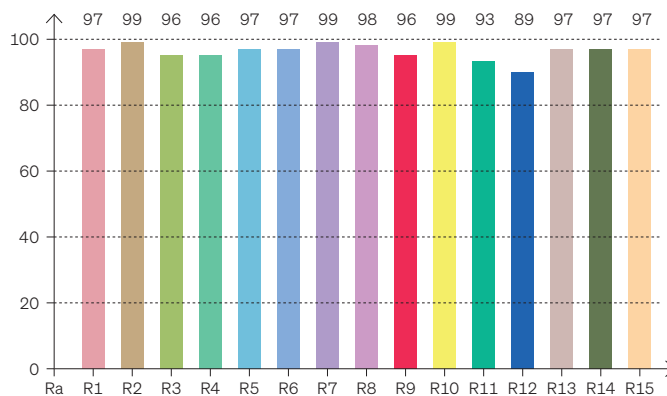

* Values taken from sample measurements
* Valori presi da misurazioni a campione

CRI Values Valori CRI

CCTK: ● 3000 K

CRI	R1	R2	R3	R4	R5	R6	R7	R8	R9	R10	R11	R12	R13	R14	R15
97,4	97	99	96	96	97	97	99	98	96	99	93	89	97	97	97

Color Parameters Parametri del colore

Color Temperature	Color Render Index	Red Component	Color Fidelity	Color Gamut	Color Quality Scale	Color Coord. CIE 1931	Color Coord. CIE 1931	Color Coordinate	Color Coordinate	Color Deviation from Black Body
CCT K	CRI	CRI R9	TM30 Rf	TM30 Rg	CQS	X	Y	U	V	ΔUV
3067 K	97,4	96,3	95,8	102,3	96,3	0,431	0,399	0,249	0,346	-0,0010

Cable outlet Uscita cavi

Right side same to left side Lato destro e sinistro uguali

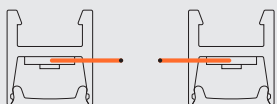
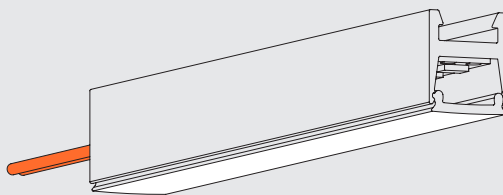
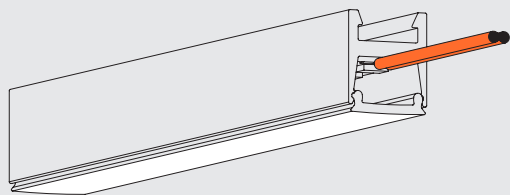

Warnings Avvertenze

The installation of the product, must be done as illustrated in the catalogue or inside the technical data-sheet that can be asked to the manufacturer.

An installation performed differently from the one indicated may compromise the durability and characteristics of the product itself.

An installation performed differently from the one indicated may compromise the durability and characteristics of the product.

Unsuitable cross-section / length of the cable can negatively affect the lighting power of the product. If Power supplies, even those with a plastic case, are located in spaces that are too small for their dimensions; they will be subjected to dissipation problems that will compromise their functionality. Silicones or resins subjected to temperature changes and used near the product, if not in accordance with the specifications issued by the manufacturer, they can seriously damage the LED component. The products can not be modified without any authorization by the manufacturer.

L'installazione del prodotto, dovrà eseguirsi come illustrato nel catalogo o nella documentazione tecnica richiedibile al produttore. Un'installazione eseguita diversamente da quella indicata, può compromettere la durata e le caratteristiche del prodotto.

Prima dell'installazione verificare la corretta sezione del cavo collegato tra LED e alimentatore.

Sezione / lunghezza del cavo non congrui, possono alterare in negativo la luminosità del prodotto. Gli alimentatori, anche quelli con contenitore plastico, inseriti in spazi troppo piccoli, saranno soggetti a problemi di dissipazione che comprometteranno la loro funzionalità. Siliconi o resine soggetti a sbalzi di temperature e utilizzati in prossimità del prodotto, se non conformi alle specifiche rilasciate dal produttore possono danneggiare gravemente il componente LED. I prodotti non possono essere modificati senza autorizzazione da parte del produttore.