

Nettuno

IP65

144 LED/m • 44 LED/ft

10,0 W/m • 3,1 W/ft

168 LED/m • 52 LED/ft

15,0 W/m • 4,6 W/ft

182 LED/m • 56 LED/ft

20,0 W/m • 6,1 W/ft

TW - 252 LED/m • 77 LED/ft Tunable White

20,0 W/m • 6,1 W/ft

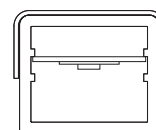
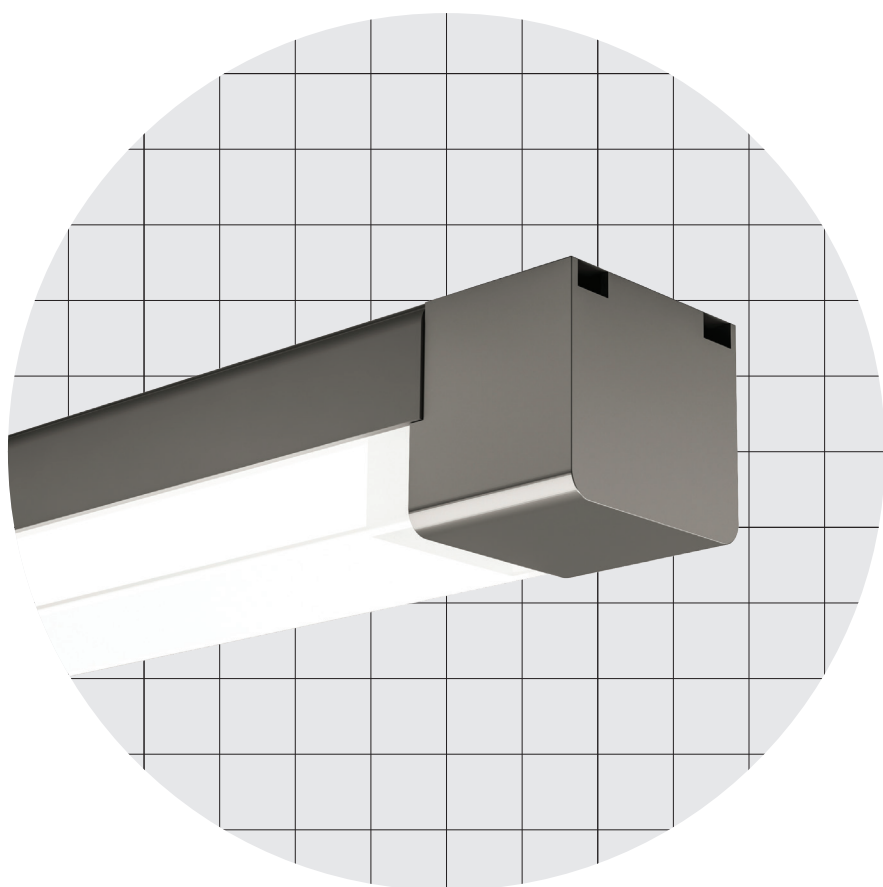

20,0 × 16,3 mm
0,79 × 0,64 "

Nettuno

IP65

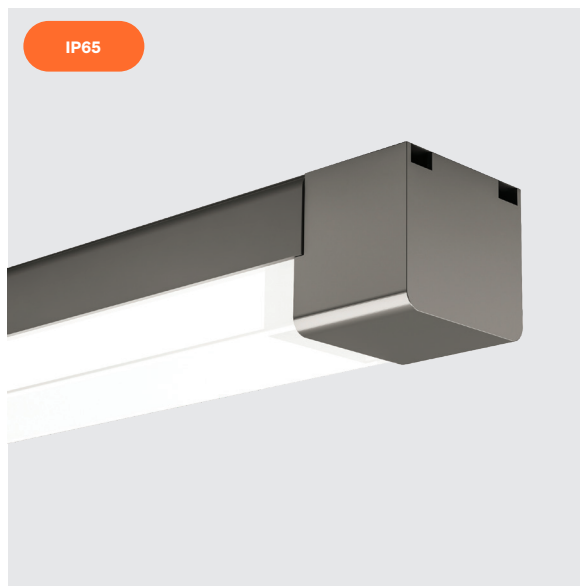

Vanish

Body Corpo

Symmetrical linear profile

Profilo lineare simmetrico

Fastening Fissaggio	Heads with screws	Testatine con viti
Screen Schermo	Opal OP50 (Screening 50%)	Opale OP50 (Scherm. 50%)
Wiring set Cavo alimentazione	2000 mm • 78,74 "	2000 mm
Custom size Lunghezza ordinabile	2000 mm • 78,74 "	2000 mm
Finishing Finitura	Polish steel and opal white polycarbonate	Acciaio lucido e policarbonato bianco opale

Listings and marks

Certificazioni e marchi



LED
LED



Light Luce

Light source Sorgente luminosa	144 LED/m • 44 LED/ft	168 LED/m • 52 LED/ft	182 LED/m • 56 LED/ft	TW - 252 LED/m • 77 LED/ft Tunable White
Power consumption Consumo energia	10,0 W/m • 3,1 W/ft	15,0 W/m • 4,6 W/ft	20,0 W/m • 6,1 W/ft	20,0 W/m • 6,1 W/ft
CCT K Mixing on demand Miscelazione su richiesta	● 2700 K ● 3000 K ● 3500 K ● 4000 K ● 5000 K	● 2700 K ● 3000 K ● 3500 K ● 4000 K ● 5000 K	● 2700 K ● 3000 K ● 3500 K ● 4000 K ● 5000 K	● 2200 - 5700 K
CRI R9 Rf @ 3000 K Rg @ 3000 K MacAdam ellipse	Min 90 Min 50 92 100 3	Min 90 Min 50 92 100 3	Min 90 Min 50 92 100 3	Min 90 Min 50 92 100 3
Luminous flux Flusso luminoso ● 3000 K	↓ OP50 - 52 lm/W 520 lm/m • 159 lm/ft	↓ OP50 - 56 lm/W 846 lm/m • 258 lm/ft	↓ OP50 - 65 lm/W 1312 lm/m • 400 lm/ft	↓ OP50 - 36 lm/W 720 lm/m • 220 lm/ft
Input voltage Tensione di ingresso	24 V DC	24 V DC	24 V DC	24 V DC

Nettuno

Dimensions Dimensioni

Scale/Scala 1:1

TE Heads with screws
Testatine con viti

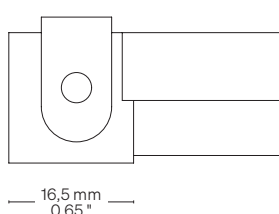
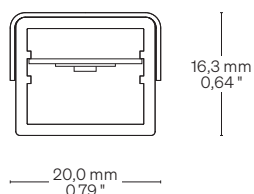

Fastening options Opzioni di fissaggio

TE Heads with screws
Testatine con viti

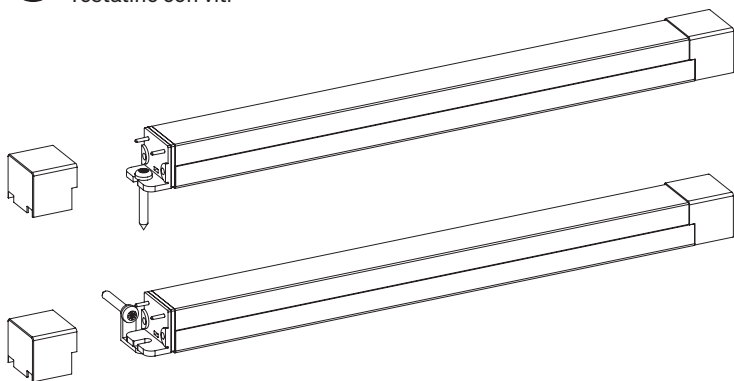

Order code Codice ordine

Basic codes Codici base

- **NESF144** Nettuno
144 LED/m • 44 LED/ft
10,0 W/m • 3,1 W/ft
- **NESF168** Nettuno
168 LED/m • 52 LED/ft
15,0 W/m • 4,6 W/ft
- **NESF182** Nettuno
182 LED/m • 56 LED/ft
20,0 W/m • 6,1 W/ft
- **NESF252** Nettuno
TW 252 LED/m • 77 LED/ft
● 2200 - 5700 K
20,0 W/m • 6,1 W/ft

CCT K CCT K

- **WW27** ● 2700 K
- **WW30** ● 3000 K
- **NW35** ● 3500 K
- **NW** ● 4000 K
- **CW** ● 5000 K

Fastening options Opzioni di fissaggio

- **TE** Heads with screws
Testatine con viti

Screens Schermi

- **OP50** Opal/Opale 50

Custom size Lunghezza ordinabile

- **--** Specify the size
Specificare la misura

Order example Esempio ordine

- **NESF144 WW27 TE OP50 • 0,32**

Nettuno, 144 LED/m • 44 LED/ft
10,0 W/m • 3,1 W/ft, Warm White 2700,
Heads with screws, Opal 50 screen • 0,32 m

Nettuno, 144 LED/m, 10,0 W/m,
Warm White 2700, Testatine con viti,
Schermo opale 50 • 0,32 m

Cable outlet Uscita cavi

Right side same to left side Lato destro e sinistro uguali

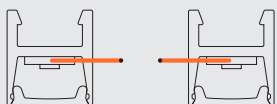
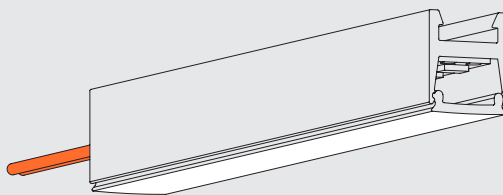
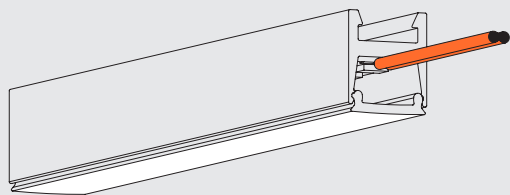

Warnings Avvertenze

The installation of the product, must be done as illustrated in the catalogue or inside the technical data-sheet that can be asked to the manufacturer. An installation performed differently from the one indicated may compromise the durability and characteristics of the product itself.

An installation performed differently from the one indicated may compromise the durability and characteristics of the product.

Unsuitable cross-section / length of the cable can negatively affect the lighting power of the product. If Power supplies, even those with a plastic case, are located in spaces that are too small for their dimensions; they will be subjected to dissipation problems that will compromise their functionality. Silicones or resins subjected to temperature changes and used near the product, if not in accordance with the specifications issued by the manufacturer, they can seriously damage the LED component. The products can not be modified without any authorization by the manufacturer.

L'installazione del prodotto, dovrà eseguirsi come illustrato nel catalogo o nella documentazione tecnica richiedibile al produttore. Un'installazione eseguita diversamente da quella indicata, può compromettere la durata e le caratteristiche del prodotto.

Prima dell'installazione verificare la corretta sezione del cavo collegato tra LED e alimentatore.

Sezione / lunghezza del cavo non congrui, possono alterare in negativo la luminosità del prodotto. Gli alimentatori, anche quelli con contenitore plastico, inseriti in spazi troppo piccoli, saranno soggetti a problemi di dissipazione che comprometteranno la loro funzionalità. Siliconi o resine soggetti a sbalzi di temperature e utilizzati in prossimità del prodotto, se non conformi alle specifiche rilasciate dal produttore possono danneggiare gravemente il componente LED. I prodotti non possono essere modificati senza autorizzazione da parte del produttore.