

Zaira

144 LED/m • 44 LED/ft

10,0 W/m • 3,1 W/ft

168 LED/m • 52 LED/ft

15,0 W/m • 4,6 W/ft

182 LED/m • 55 LED/ft

20,0 W/m • 6,1 W/ft

TW - 252 LED/m • 77 LED/ft Tunable White

20,0 W/m • 6,1 W/ft

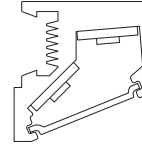

18,0 × 18,5 mm
0,71 × 0,73 "

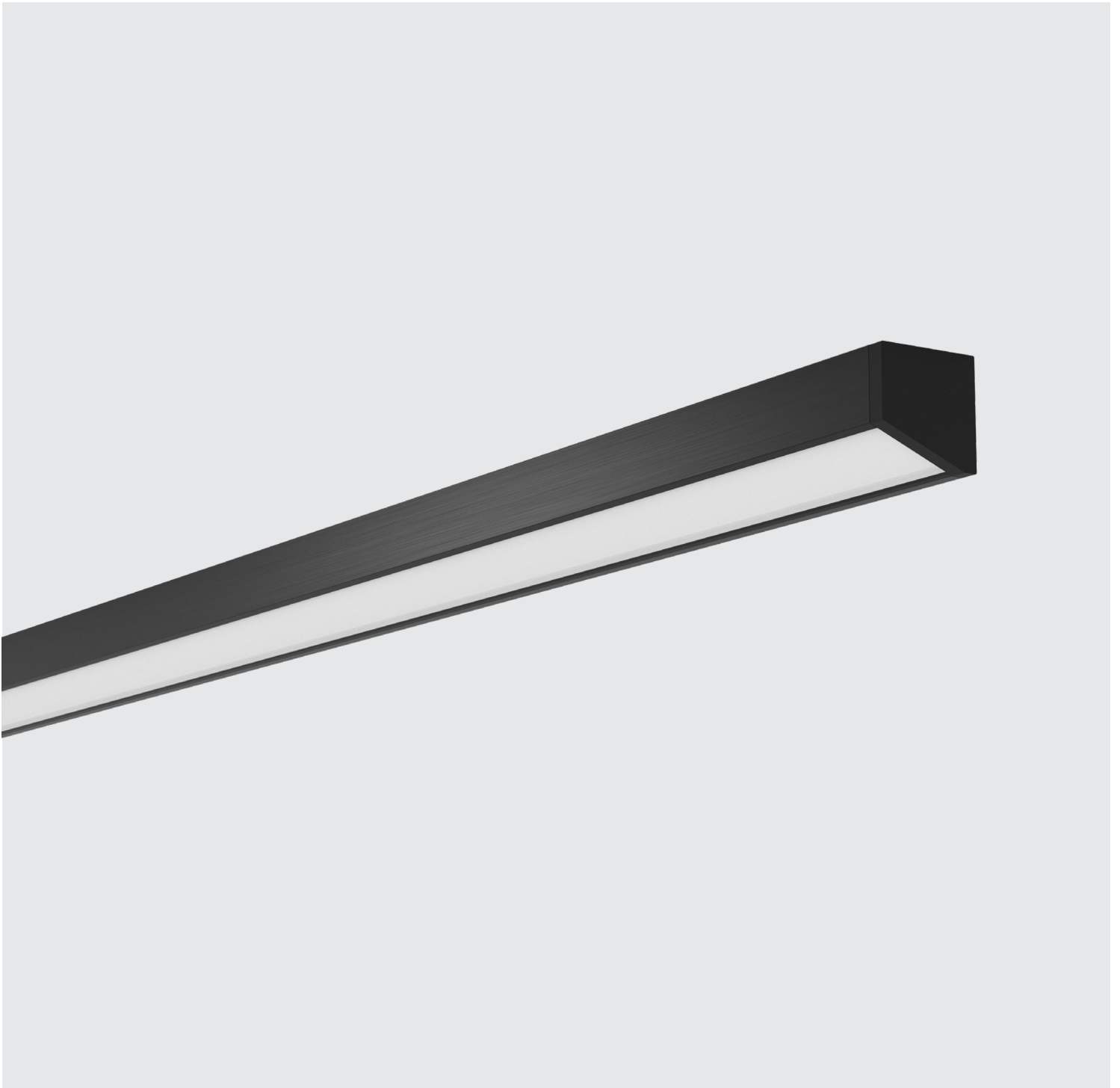

Zaira



Sharp Asym.

Body Corpo

Asymmetric linear profile

Profilo lineare asimmetrico

Fastening Fissaggio	Caps + Plastic clips	Tappi + Clip in plastica
	Caps + Magnets	Tappi + Magneti
Screen Schermo	Transparent 7 (Screening 7%)	Trasparente 7 (Schermatura 7%)
	Opal 30 (Screening 30%)	Opale 30 (Scherm. 30%)
	Opal 50 (Screening 50%)	Opale 50 (Scherm. 50%)
Wiring set Cavo alimentazione	2000 mm • 78,74 "	2000 mm
Custom size Lunghezza ordinabile	Up to 3000 mm • 118,10 "	Fino a 3000 mm
Finishing Finitura	● Grey anodized (Standard)	
	→ On request other finishes	
	● Anodica grigia (Standard)	
	→ Su richiesta altre finiture	

Listings and marks

Certificazioni e marchi



Where we produce

Dove produciamo

Made in Italy

LED (See page CRI)

LED (Vedi pagina CRI)

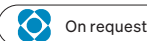

Light Luce

	144 LED/m • 44 LED/ft	168 LED/m • 52 LED/ft	182 LED/m • 55 LED/ft	TW - 252 LED/m • 77 LED/ft Tunable White
Light source Sorgente luminosa	144 LED/m • 44 LED/ft	168 LED/m • 52 LED/ft	182 LED/m • 55 LED/ft	TW - 252 LED/m • 77 LED/ft Tunable White
Power consumption Consumo energia	10,0 W/m • 3,1 W/ft	15,0 W/m • 4,6 W/ft	20,0 W/m • 6,1 W/ft	20,0 W/m • 6,1 W/ft
CCT K	● 1800 ● 2500 ● 3500 ● 2000 ● 2700 ● 4000 ● 2200 ● 3000 ● 5000	● 1800 ● 2500 ● 3500 ● 2000 ● 2700 ● 4000 ● 2200 ● 3000 ● 5000	● 1800 ● 2500 ● 3500 ● 2000 ● 2700 ● 4000 ● 2200 ● 3000 ● 5000	● 2200 - 5700 K
CRI R9 Rf @ 3000 K Rg @ 3000 K MacAdam ellipse	Min 90 Min 50 92 100 3	Min 90 Min 50 92 100 3	Min 90 Min 50 92 100 3	Min 90 Min 50 92 100 3
Delivered lumen output Flusso luminoso emesso ● 3000 K	↓ A - T7 - 132 lm/W 1320 lm/m • 402 lm/ft ↓ A - O3 - 91 lm/W 908 lm/m • 277 lm/ft ↓ A - O5 - 74 lm/W 743 lm/m • 227 lm/ft	↓ A - T7 - 143 lm/W 2148 lm/m • 655 lm/ft ↓ A - O3 - 98 lm/W 1477 lm/m • 450 lm/ft ↓ A - O5 - 81 lm/W 1207 lm/m • 368 lm/ft	↓ A - T7 - 144 lm/W 2886 lm/m • 880 lm/ft ↓ A - O3 - 99 lm/W 1985 lm/m • 605 lm/ft ↓ A - O5 - 81 lm/W 1623 lm/m • 495 lm/ft	↓ A - T7 - 72 lm/W 1440 lm/m • 439 lm/ft ↓ A - O3 - 50 lm/W 990 lm/m • 302 lm/ft ↓ A - O5 - 41 lm/W 810 lm/m • 247 lm/ft
Delivered lumen output Flusso luminoso emesso ● 3000 K	↓ B - T7 - 132 lm/W 1321 lm/m • 403 lm/ft ↓ B - O3 - 88 lm/W 875 lm/m • 267 lm/ft ↓ B - O5 - 66 lm/W 660 lm/m • 201 lm/ft	↓ B - T7 - 143 lm/W 2148 lm/m • 655 lm/ft ↓ B - O3 - 95 lm/W 1422 lm/m • 434 lm/ft ↓ B - O5 - 72 lm/W 1074 lm/m • 327 lm/ft	↓ B - T7 - 144 lm/W 2886 lm/m • 880 lm/ft ↓ B - O3 - 96 lm/W 1911 lm/m • 583 lm/ft ↓ B - O5 - 72 lm/W 1443 lm/m • 440 lm/ft	↓ B - T7 - 72 lm/W 1440 lm/m • 439 lm/ft ↓ B - O3 - 48 lm/W 954 lm/m • 291 lm/ft ↓ B - O5 - 36 lm/W 720 lm/m • 220 lm/ft
Input voltage Tensione di ingresso	24 V DC	24 V DC	24 V DC	24 V DC

TA Caps + Plastic clips
Tappi + Clip in plastica

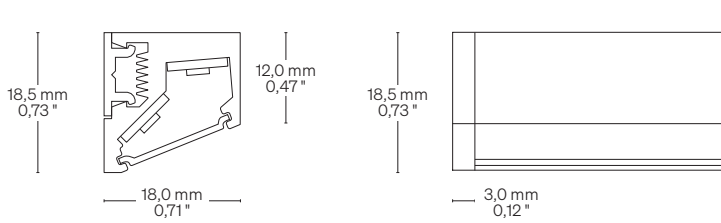

TAM Caps + Magnets
Tappi + Magneti

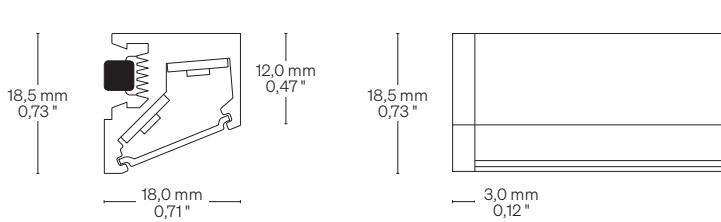

Strip LED position Posizione strip LED

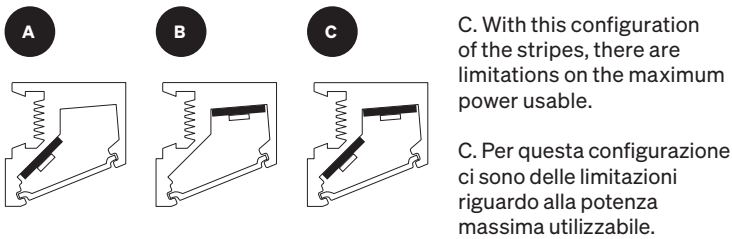

Fastening options Opzioni di fissaggio

TA Caps + Plastic clips
Tappi + Clip in plastica

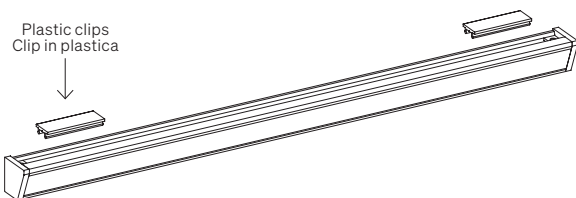

TAM Caps + Magnets
Tappi + Magneti

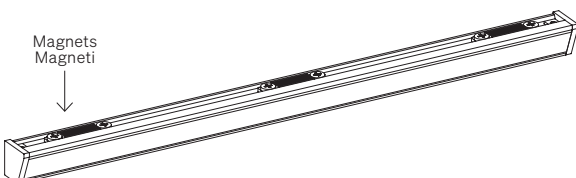

Zaira

Order code Codice ordine	
Basic code Codice base	<ul style="list-style-type: none"> • ZA144 Zaira 144 LED/m • 44 LED/ft 10,0 W/m • 3,1 W/ft • ZA168 Zaira 168 LED/m • 52 LED/ft 15,0 W/m • 4,6 W/ft • ZA182 Zaira 182 LED/m • 55 LED/ft 20,0 W/m • 6,1 W/ft • ZA252 Zaira TW 252 LED/m • 77 LED/ft ● 2200 - 5700 K 20,0 W/m • 6,1 W/ft
CCT K CCT K	<ul style="list-style-type: none"> • 18 ● 1800 K • 20 ● 2000 K • 22 ● 2200 K • 25 ● 2500 K • 27 ● 2700 K • 30 ● 3000 K • 35 ● 3500 K • 40 ● 4000 K • 50 ● 5000 K
Strip LED position Posizione strip LED	<ul style="list-style-type: none"> • A Side Laterale • B Zenith. On the plane Zenitale. Sul piano • C Double strip LED Doppia strip LED
Fastening options Opzioni di fissaggio	<ul style="list-style-type: none"> • TA Caps + Plastic clips Tappi + Clip in plastica • TAM Caps + Magnets Tappi + Magneti
Screen Schermo	<ul style="list-style-type: none"> • T7 Transparent/Trasparente 7 • O3 Opal/Opale 30 • O5 Opal/Opale 50
Finishing Finitura	<ul style="list-style-type: none"> • 01 ● Grey anodized ● Anodica grigia
Ordering length Lunghezza ordinabile	<ul style="list-style-type: none"> • -- → Specify the custom size or visit formulaluci.com, for standard length. → Specificare la misura custom oppure visitare il sito formulaluci.com, per le lunghezze standard.
Order example Esempio ordine	<ul style="list-style-type: none"> • ZA144 18 A TA T7 01 • 0,32 Zaira, 144 LED/m • 44 LED/ft, 10,0 W/m • 3,1 W/ft, Warm White 1800, Side, Caps + Plastic clips, Transparent 7, Grey anodized • 0,32 m Zaira, 144 LED/m, 10,0 W/m, Warm White 1800, Laterale, Tappi + Clip in plastica, Trasparente 7, Anodica grigia • 0,32 m

Zaira

Cable outlet Uscita cavi

Left side

Lato sinistra

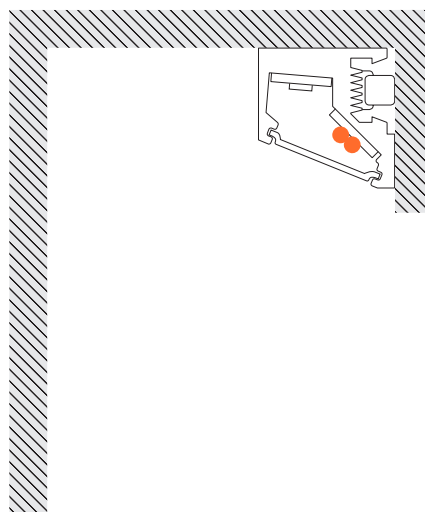
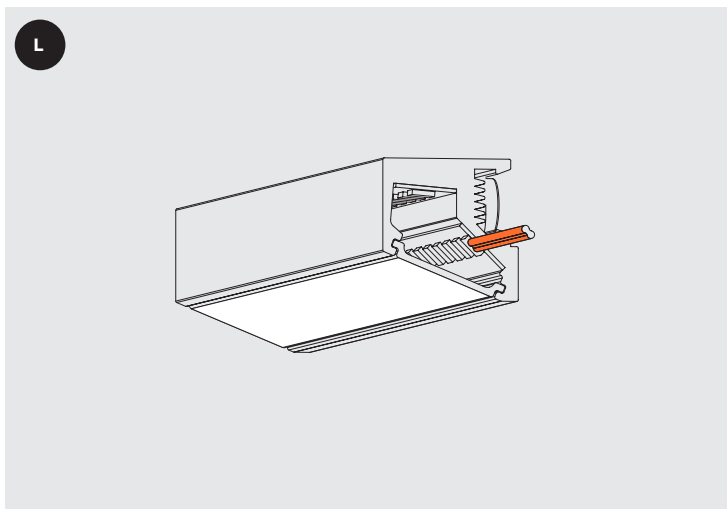

Scale/Scala 1:1

Right side

Lato destro

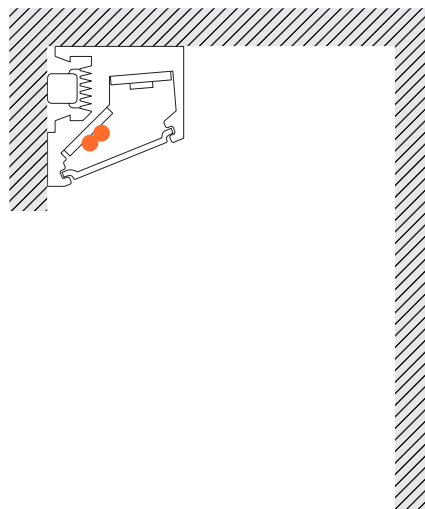
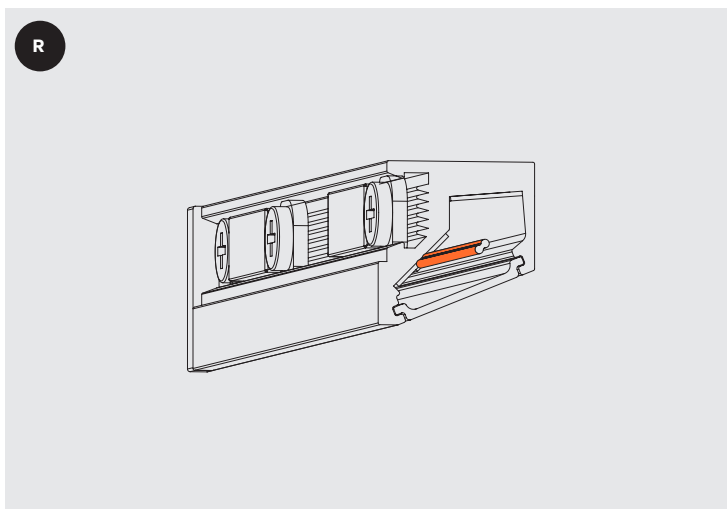

Scale/Scala 1:1

CRI Typical* CRI Tipici*



R9050 - H6 • 3SDCM

High Efficacy

● 3000 K

CRI: 94,5 (R1-R8)

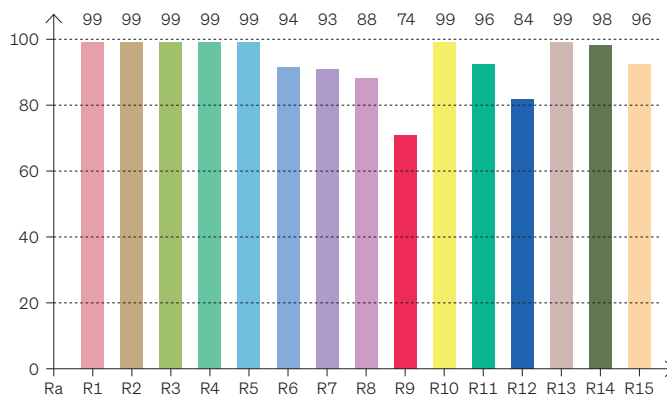

* Values taken from sample measurements
* Valori presi da misurazioni a campione

CRI Values Valori CRI

CCTK: ● 3000 K

CRI	R1	R2	R3	R4	R5	R6	R7	R8	R9	R10	R11	R12	R13	R14	R15
94,4	99	99	99	99	99	94	93	88	74	99	96	84	99	98	96

Color Parameters Parametri del colore

Color Temperature	Color Render Index	Red Component	Color Fidelity	Color Gamut	Color Quality Scale	Color Coord. CIE 1931	Color Coord. CIE 1931	Color Coordinate	Color Coordinate	Color Deviation from Black Body
CCT K	CRI	CRI R9	TM30 Rf	TM30 Rg	CQS	X	Y	U	V	ΔUV
3042 K	96,2	74,4	92,2	100,5	92,9	0,441	0,399	0,255	0,347	-0,0009



FULL SPECTRUM • 3SDCM

OPTISOLIS™

● 3000 K

CRI: 97,0 (R1-R8)

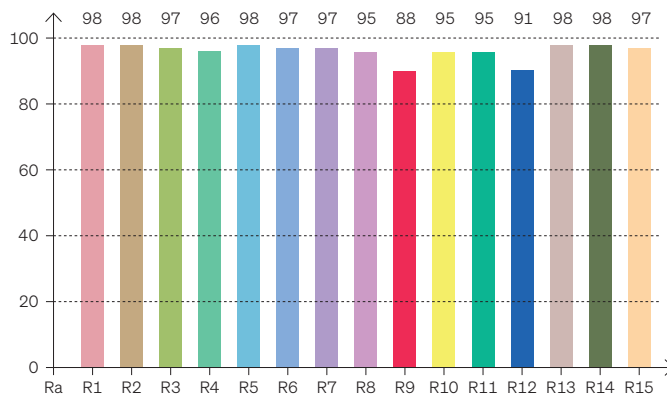

* Values taken from sample measurements
* Valori presi da misurazioni a campione

CRI Values Valori CRI

CCTK: ● 3000 K

CRI	R1	R2	R3	R4	R5	R6	R7	R8	R9	R10	R11	R12	R13	R14	R15
97,0	98	98	97	96	98	97	97	95	88	95	95	91	98	98	97

Color Parameters Parametri del colore

Color Temperature	Color Render Index	Red Component	Color Fidelity	Color Gamut	Color Quality Scale	Color Coord. CIE 1931	Color Coord. CIE 1931	Color Coordinate	Color Coordinate	Color Deviation from Black Body
CCT K	CRI	CRI R9	TM30 Rf	TM30 Rg	CQS	X	Y	U	V	ΔUV
3059 K	97,0	88,0	94,8	102,8	94,5	0,432	0,400	0,249	0,346	-0,0008

Warnings Avvertenze

The installation of the product, must be done as illustrated in the catalogue or inside the technical data-sheet that can be asked to the manufacturer. An installation performed differently from the one indicated may compromise the durability and characteristics of the product itself.

An installation performed differently from the one indicated may compromise the durability and characteristics of the product. Unsuitable cross-section / length of the cable can negatively affect the lighting power of the product. If Power supplies, even those with a plastic case, are located in spaces that are too small for their dimensions; they will be subjected to dissipation problems that will compromise their functionality. Silicones or resins subjected to temperature changes and used near the product, if not in accordance with the specifications issued by the manufacturer, they can seriously damage the LED component. The products can not be modified without any authorization by the manufacturer.

L'installazione del prodotto, dovrà eseguirsi come illustrato nel catalogo o nella documentazione tecnica richiedibile al produttore. Un'installazione eseguita diversamente da quella indicata, può compromettere la durata e le caratteristiche del prodotto.

Prima dell'installazione verificare la corretta sezione del cavo collegato tra LED e alimentatore. Sezione / lunghezza del cavo non congrui, possono alterare in negativo la luminosità del prodotto. Gli alimentatori, anche quelli con contenitore plastico, inseriti in spazi troppo piccoli, saranno soggetti a problemi di dissipazione che comprometteranno la loro funzionalità. Siliconi o resine soggetti a sbalzi di temperature e utilizzati in prossimità del prodotto, se non conformi alle specifiche rilasciate dal produttore possono danneggiare gravemente il componente LED. I prodotti non possono essere modificati senza autorizzazione da parte del produttore.