

Cable outlet Uscita cavi

Linear Light

Simmetric Simmetric ⁰¹

Angled Angolari ⁰¹

Asymmetric Asimmetrici ⁰²

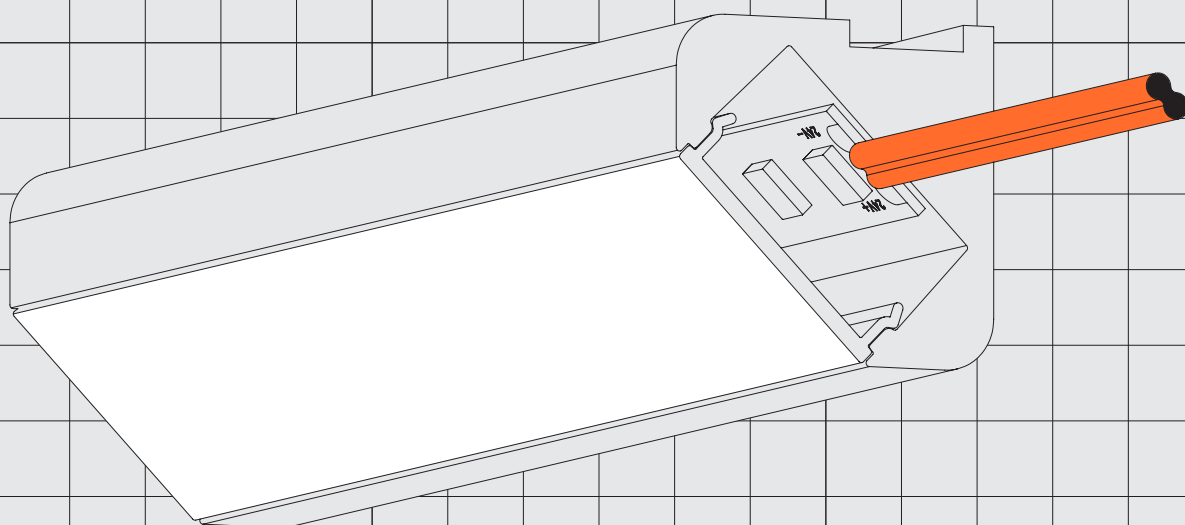

Cable outlet Uscita cavi

Right side same to left side Lato destro e sinistro uguali

R L

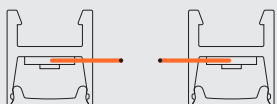
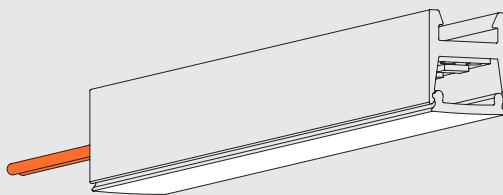
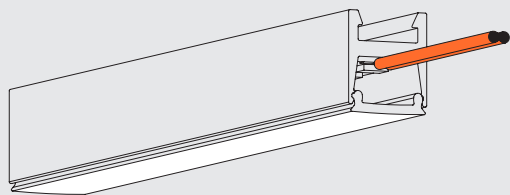

Products Prodotti

Aiko 5
Aiko 8
FRS99
133 Mini
133 Mini Lens
133 & 133 P5/P7
Lens
Oslo
Hida
Nettuno
Mirage & Mirage P5/P7
Plano
Nevada & Nevada P5/P7
Plank Optics
Hida P5/P7
133 Lens Optics P5/P7
Lensbar Square P5

Left side Lato sinistro

L

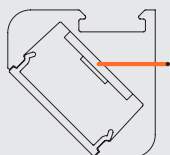
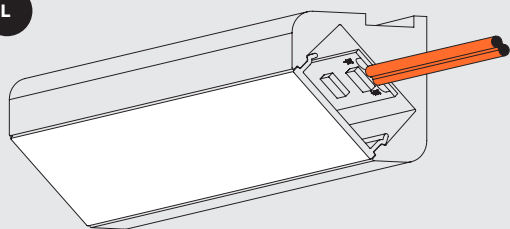

Right side Lato destro

R

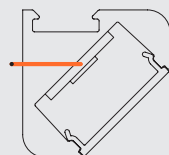
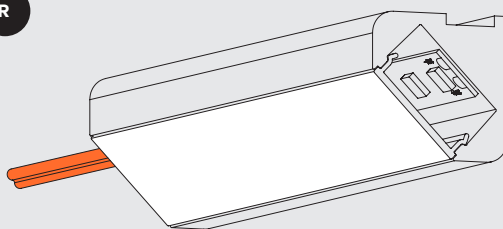

Products Prodotti

Tokio Nano
Tokio Micro
Tokio Mini
Tokio Mini Lens
Tokio / Tokio P5/P7
Tokio Blues
Tokio Blues 144
Riga + Blues
Riga + Lens

Uscita cavi Cable Outlet

Left side Lato sinistro

L

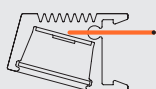
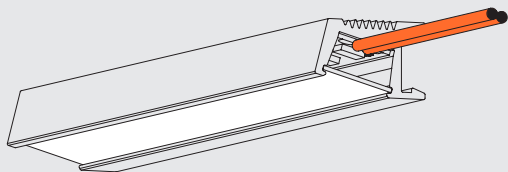

Right side Lato destro

R

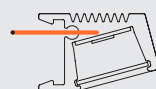
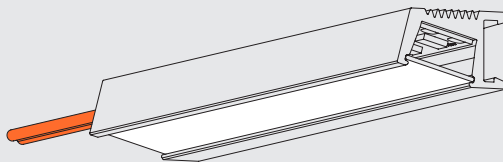

Products Prodotti

Kobe Lens

Left side Lato sinistro

L

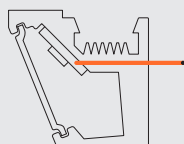
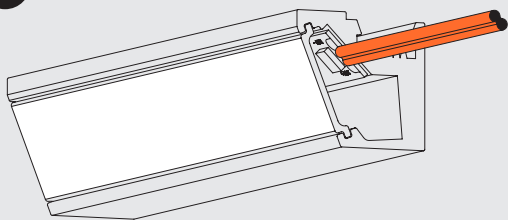

Right side Lato destro

R

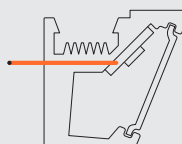
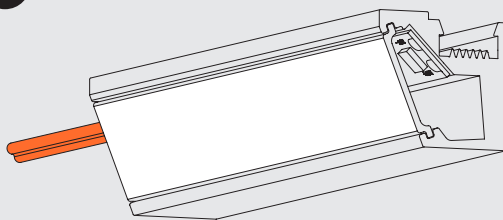

Products Prodotti

Zaira

Left side Lato sinistro

L

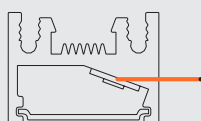
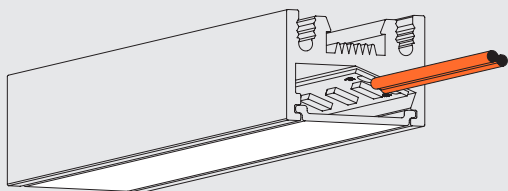

Right side Lato destro

R

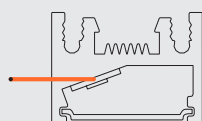
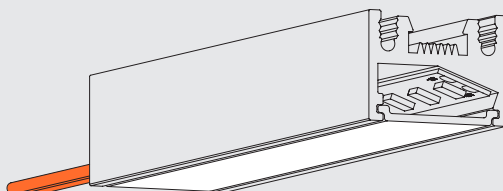

Products Prodotti

Glider