

# TOP Mini

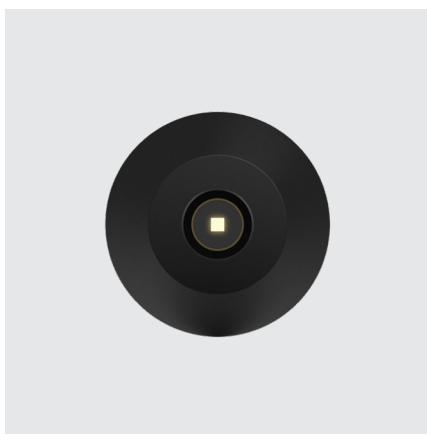

# TOP Mini



## Body Corpo

### Aluminium spot

Spot in alluminio

### Fastening

Fissaggio

Pressure

A pressione

### Wiring set

Cavo alimentazione

1500 mm • 59,06 "

1500 mm

### Finishing

Finitura

- Black varnish
- On request other finishes
- Vernice nera
- Su richiesta altre finiture

### Listings and marks

Certificazioni e marchi



### Where we produce

Dove produciamo

Made in Italy

### LED (See page CRI)

LED (Vedi pagina CRI)



## Light Luce

### Light source

Sorgente luminosa

LED

↓ Series/In serie

V CC: 1,0 W

LED

↓ Parallel/In parallelo

V DC: 1,3 W

### CCT K

- 2700 K
- 3000 K
- 3500 K
- 4000 K
- 5000 K

- 2700 K
- 3000 K
- 3500 K
- 4000 K
- 5000 K

### CRI

R9

Rf @ 3000 K

Rg @ 3000 K

MacAdam ellipse

Min 90

Min 80

96

103

2

Min 90

Min 80

96

103

2

### Delivered lumen output

Flusso luminoso emesso

● 3000 K

101 lm @ 350mA

101 lm @ 24 V DC

### Input voltage/current

Tensione/Corrente di ingresso

3 V CC @350mA

24 V DC

# TOP Mini

## Dimensions Dimensioni

Scale/Scala 1:1

## Fastening options Opzioni di fissaggio

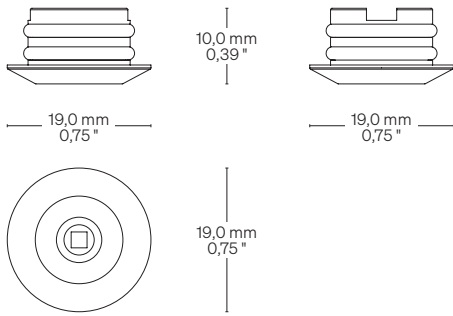

 Hole size:  $\varnothing 14,0 \text{ mm} \bullet \varnothing 0,55 \text{ ''}$   
Dimensione foro:  $\varnothing 14,0 \text{ mm}$

## Connection diagram Cablaggio

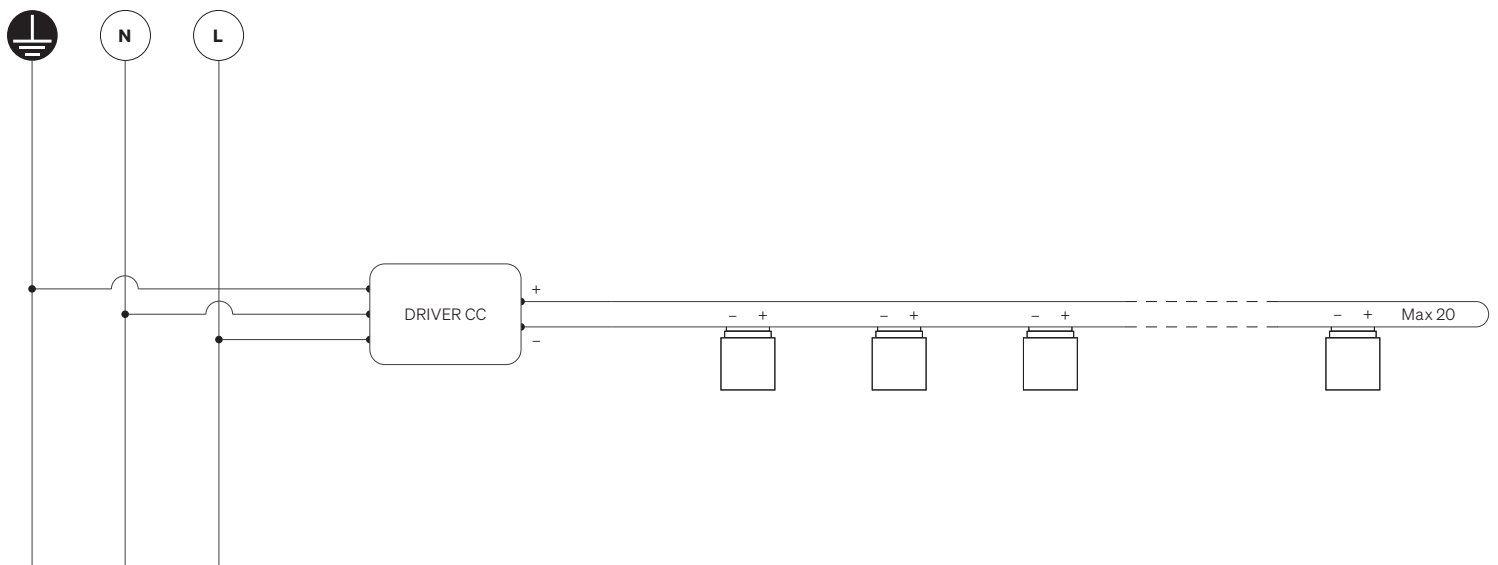
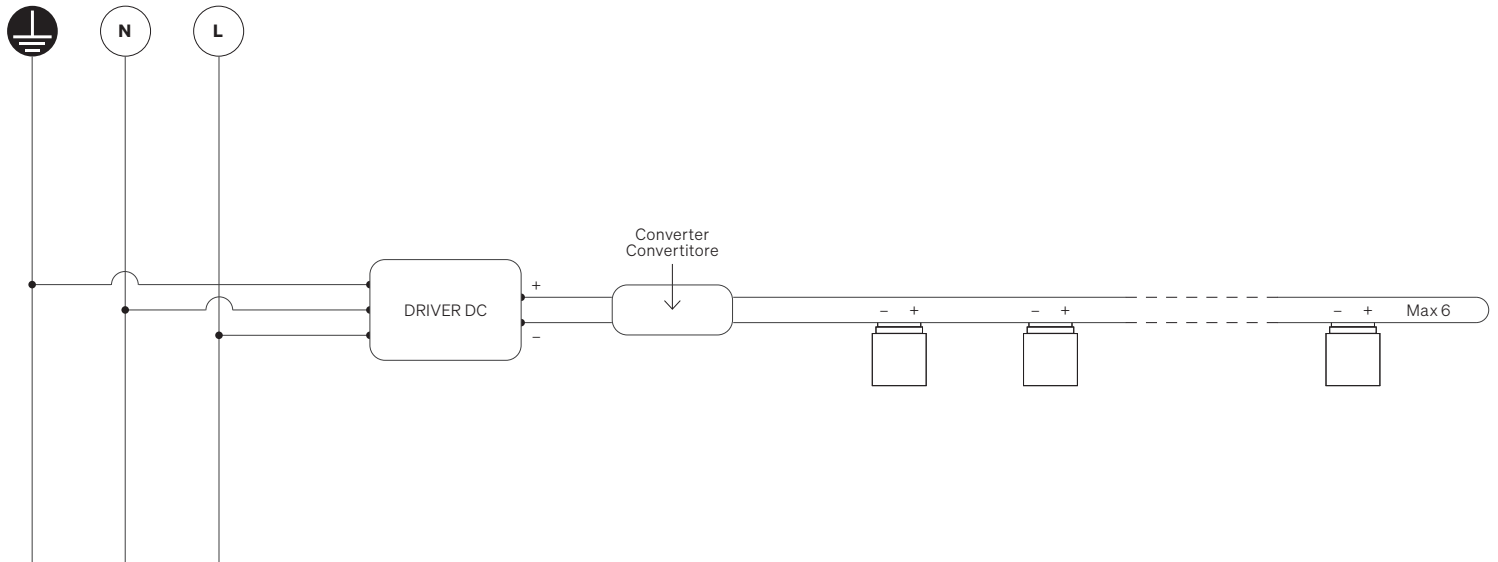

Order code Codice ordine	
<b>Basic codes</b> Codici base	<ul style="list-style-type: none"> <li>• <b>TM</b> TOP Mini</li> </ul>
<b>CCT K</b> CCT K	<ul style="list-style-type: none"> <li>• <b>WW27</b> ● 2700 K</li> <li>• <b>WW30</b> ● 3000 K</li> <li>• <b>NW35</b> ● 3500 K</li> <li>• <b>NW</b> ● 4000 K</li> <li>• <b>CW</b> ● 5000 K</li> </ul>
<b>Accessories</b> Accessori	<ul style="list-style-type: none"> <li>• <b>DRPWM</b> Converter 24 V DC Convertitore 24 V DC</li> <li>• <b>DRDC</b> Converter 24 V DC Potential different dimmer Convertitore 24 V DC Dimmerabile in tensione</li> </ul>
<b>Order example</b> Esempio ordine	<ul style="list-style-type: none"> <li>• <b>TM WW27 DRPWM</b> TOP Mini, Warm White 2700, Converter 24 V DC</li> <li>• <b>TM WW27 DRDC</b> TOP Mini, Warm White 2700, Convertitore 24 V DC</li> </ul>

The installation of the product, must be done as illustrated in the catalogue or inside the technical data-sheet that can be asked to the manufacturer.

An installation performed differently from the one indicated may compromise the durability and characteristics of the product itself.

An installation performed differently from the one indicated may compromise the durability and characteristics of the product.

Unsuitable cross-section / length of the cable can negatively affect the lighting power of the product. If Power supplies, even those with a plastic case, are located in spaces that are too small for their dimensions; they will be subjected to dissipation problems that will compromise their functionality. Silicones or resins subjected to temperature changes and used near the product, if not in accordance with the specifications issued by the manufacturer, they can seriously damage the LED component. The products can not be modified without any authorization by the manufacturer.

L'installazione del prodotto, dovrà eseguirsi come illustrato nel catalogo o nella documentazione tecnica richiedibile al produttore. Un'installazione eseguita diversamente da quella indicata, può compromettere la durata e le caratteristiche del prodotto.

Prima dell'installazione verificare la corretta sezione del cavo collegato tra LED e alimentatore.

Sezione / lunghezza del cavo non congrui, possono alterare in negativo la luminosità del prodotto. Gli alimentatori, anche quelli con contenitore plastico, inseriti in spazi troppo piccoli, saranno soggetti a problemi di dissipazione che comprometteranno la loro funzionalità. Siliconi o resine soggetti a sbalzi di temperature e utilizzati in prossimità del prodotto, se non conformi alle specifiche rilasciate dal produttore possono danneggiare gravemente il componente LED. I prodotti non possono essere modificati senza autorizzazione da parte del produttore.

# CRI Typical\* CRI Tipici\*

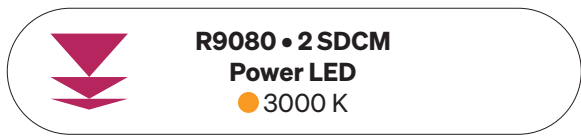

## CRI: 97,4 (R1-R8)

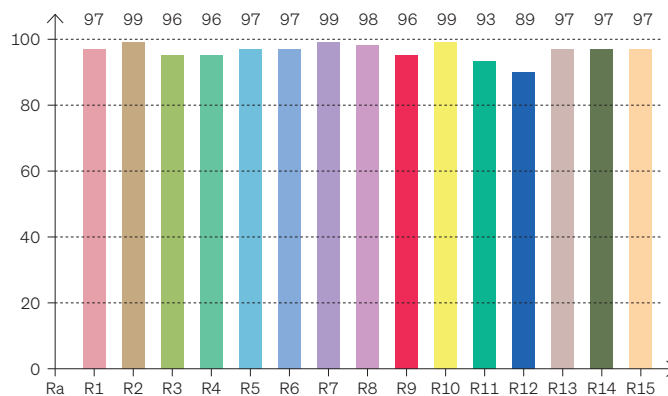

\* Values taken from sample measurements  
\* Valori presi da misurazioni a campione

## CRI Values Valori CRI

CCTK: ● 3000 K

CRI	R1	R2	R3	R4	R5	R6	R7	R8	R9	R10	R11	R12	R13	R14	R15
<b>97,4</b>	97	99	96	96	97	97	99	98	96	99	93	89	97	97	97

## Color Parameters Parametri del colore

Color Temperature	Color Render Index	Red Component	Color Fidelity	Color Gamut	Color Quality Scale	Color Coord. CIE 1931	Color Coord. CIE 1931	Color Coordinate	Color Coordinate	Color Deviation from Black Body
CCT K	CRI	CRI R9	TM30 Rf	TM30 Rg	CQS	X	Y	U	V	$\Delta UV$
3067 K	97,4	96,3	95,8	102,3	96,3	0,431	0,399	0,249	0,346	-0,0010