

TOOL Side Bend

140 LED/m • 43 LED/ft
14,4 W/m • 4,4 W/ft
TW - 140 LED/m • 43 LED/ft
14,4 W/m • 4,4 W/ft

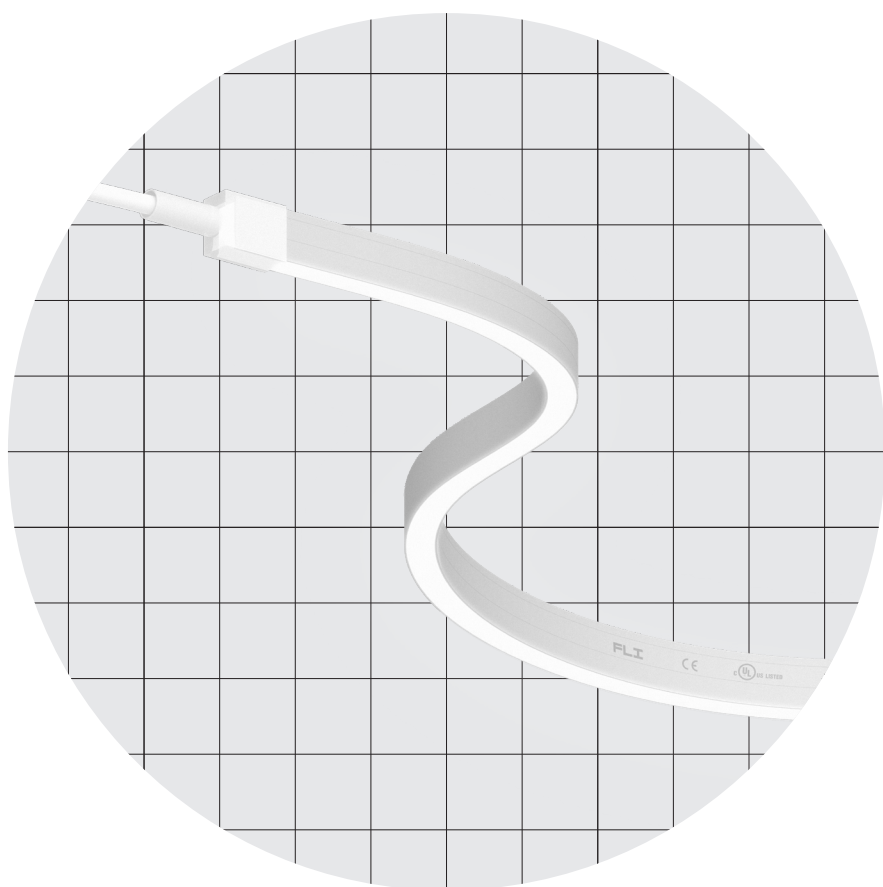

6,5 × 11,0 mm
0,26 × 0,43 "



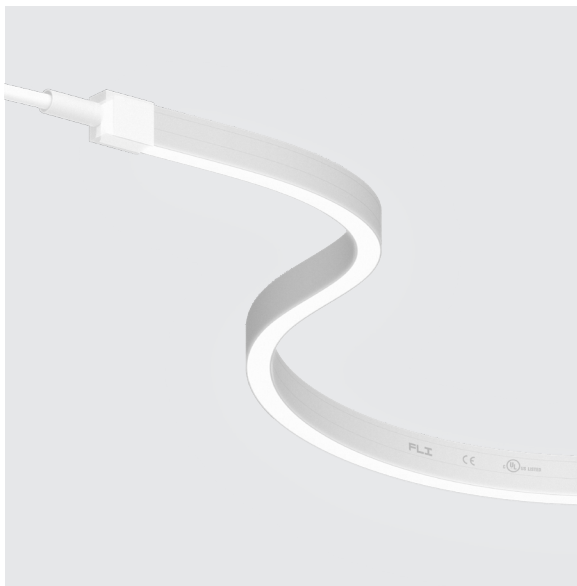



TOOL Side Bend



Body Corpo

Flexible Strip LED Side Bend

Strip LED flessibile Side Bend

Fastening Fissaggio	U metal trim Steel clips Flexible Steel Profile	Profilo metallico U Clip in acciaio Profilo in Acc. Fles.
Screen Schermo	Polyurethane resin white Opal	Resina poliuretanic bianca Opale
Custom size Lunghezza ordinabile	→ 10 m • 32,8 ft reel with power cables at both ends./ Bobina 10 m con cavi di alimentazione in entrambe le estremità. → Custom size (Up to 5 m • 16,40 ft with one power supply)./Lunghezza custom (Fino a 5 m con unica alimentazione).	
Finishing Finitura	<input type="radio"/> White	<input type="radio"/> Bianca
Listings and marks Certificazioni e marchi	     	

Light Luce

Light source Sorgente luminosa	140 LED/m • 43 LED/ft	TW - 140 LED/m • 43 LED/ft Tunable White
Power consumption Consumo energia	14,4 W/m • 4,4 W/ft	14,4 W/m • 4,4 W/ft
CCT K	<ul style="list-style-type: none"> ● 2700 K ● 3000 K ● 3500 K ● 4000 K 	● 2200 - 5700 K
CRI R9	Min 90 Min 70	Min 90 Min 70
Delivered lumen output Flusso luminoso emesso	44 lm/W 618 lm/m • 188 lm/ft ● 3000 K	32 lm/W 460 lm/m • 140 lm/ft ● 3700 K
Input voltage Tensione di ingresso	24 V DC	24 V DC

TOOL Side Bend

Dimensions Dimensioni

Scale/Scala 1:1

A → Front
A → Frontale

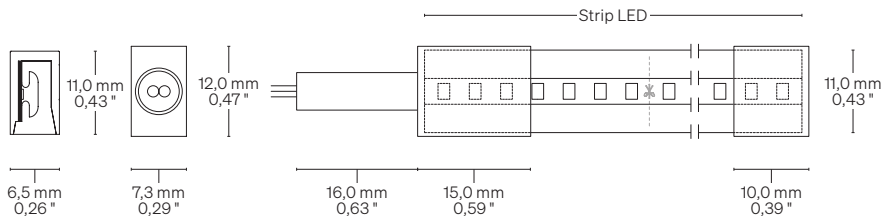

T → Top
T → Superiore

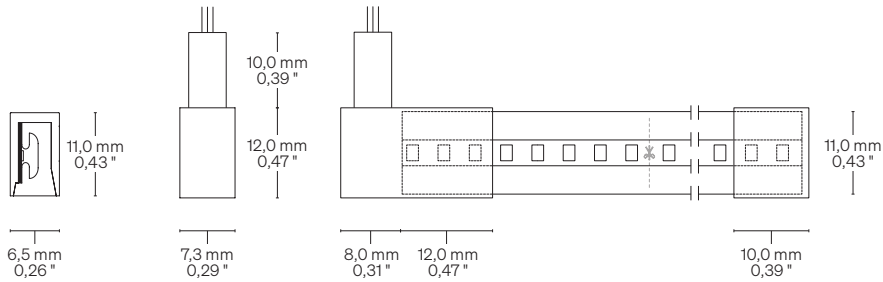

B → Bottom
B → Inferiore

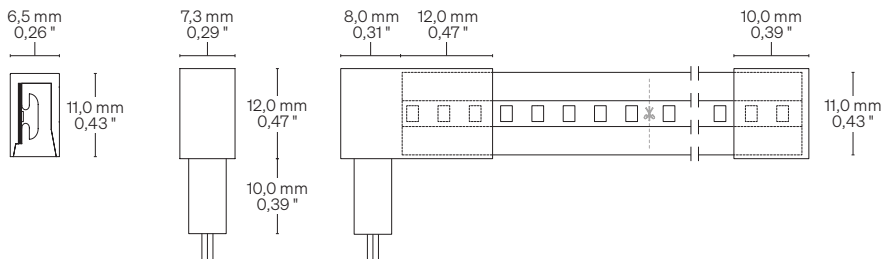

F → Side Front
F → Lato Frontale

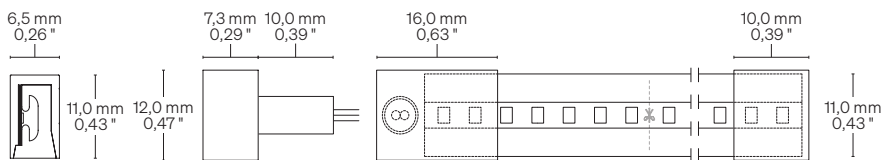

L → Side LED
L → Lato LED

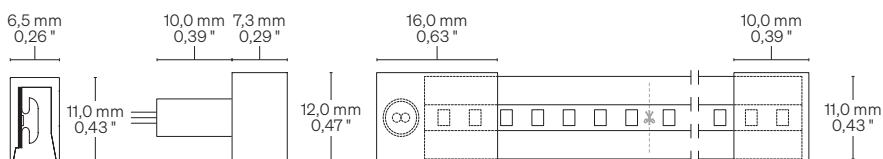

Cable outlet Uscita Cavi

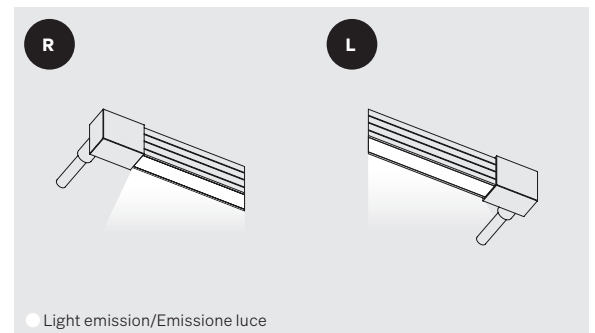
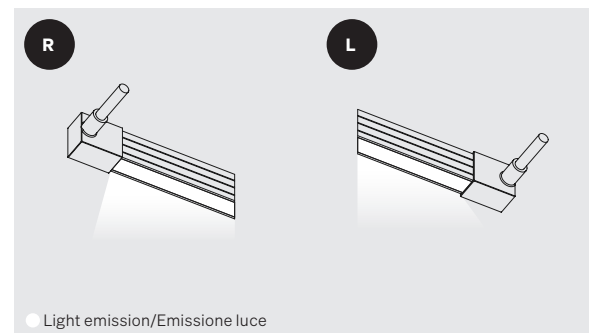
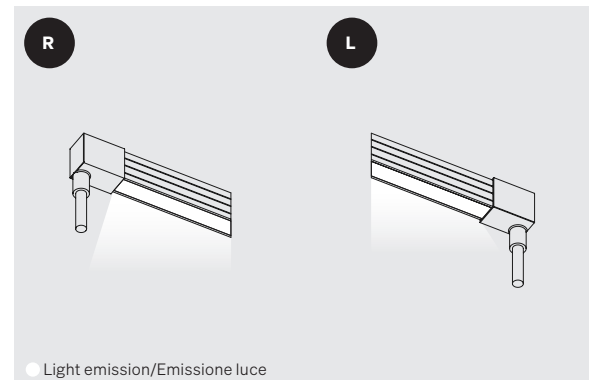
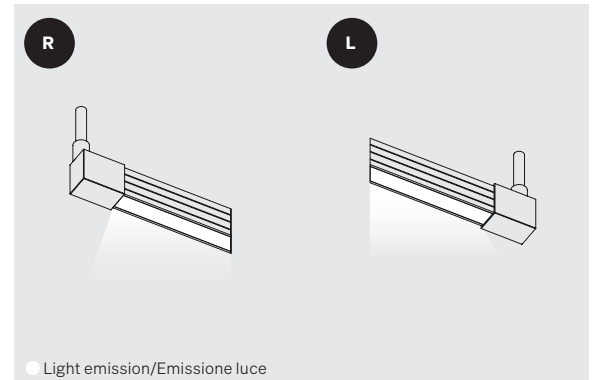
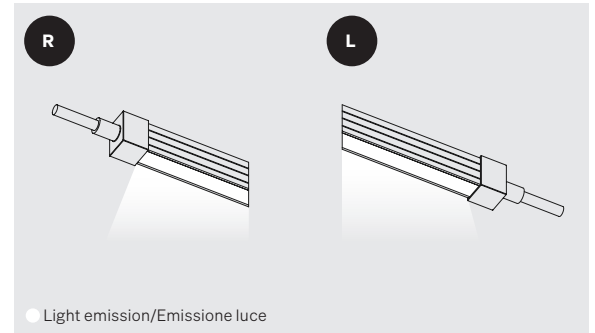

TOOL Side Bend

Cutting point information Informazioni segno di taglio

Scale/Scala 1:1

- 1** Up to 5 m • 16,40 ft with one power supply
Fino a 5 m con unica alimentazione

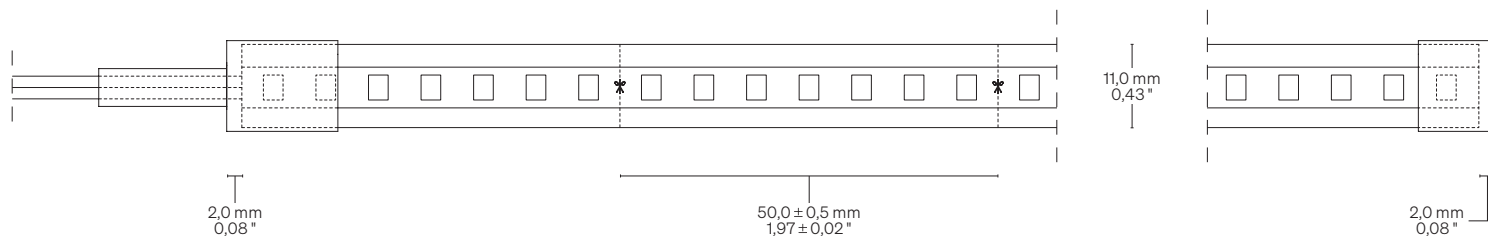

- 2** From 5 to 10 m • From 16,40 to 32,80 ft with dual power supply
Da 5 a 10 m con doppia alimentazione

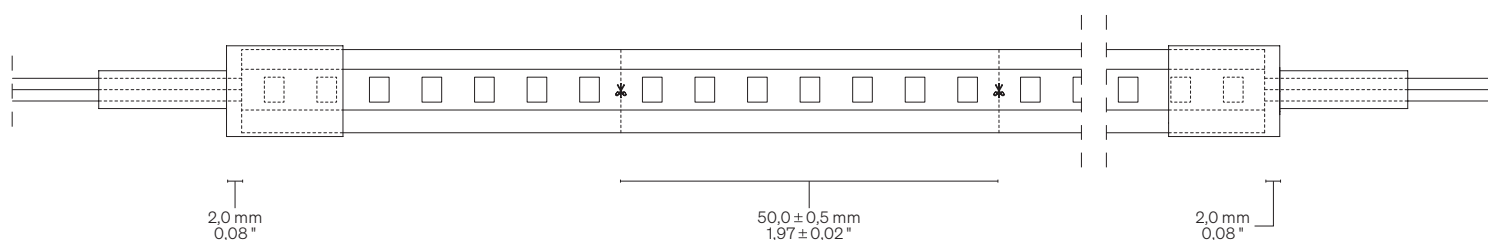

Curvature radius Raggio di curvatura

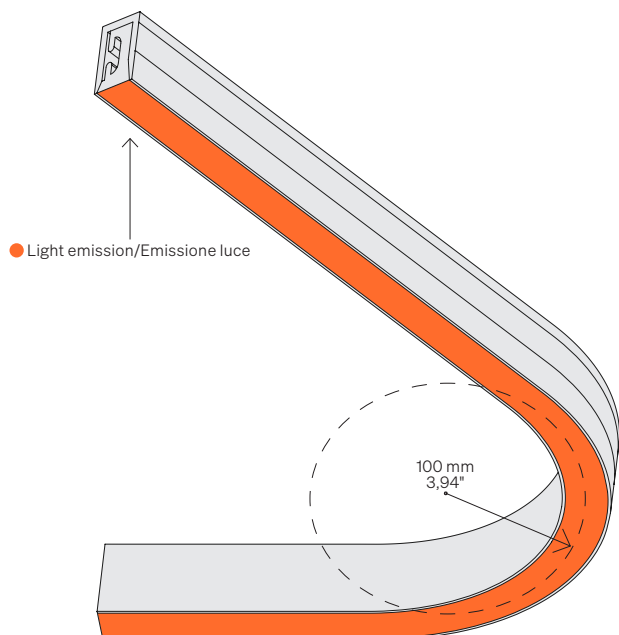

Curvature radius Raggio di curvatura

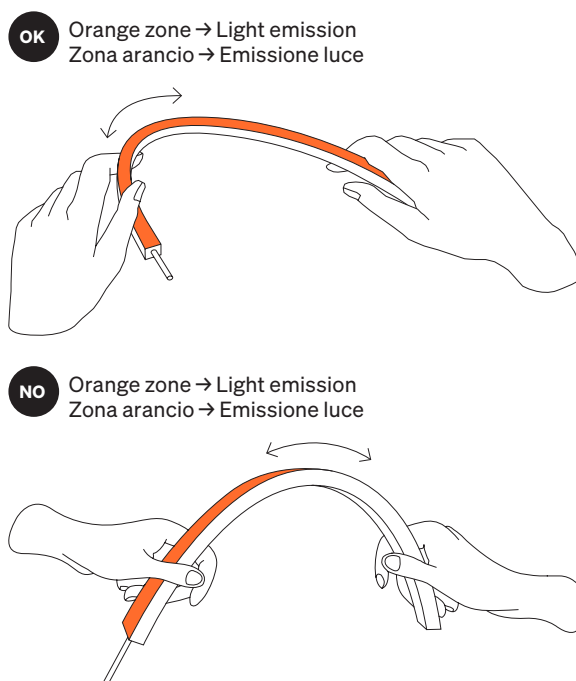

TOOL Side Bend

Fastening options Opzioni di fissaggio

Scale/Scala 1:1

TOUSB

U metal trim → Use for furniture with straight lines
Profilo metallico U → Utilizzare per arredi con linee dritte

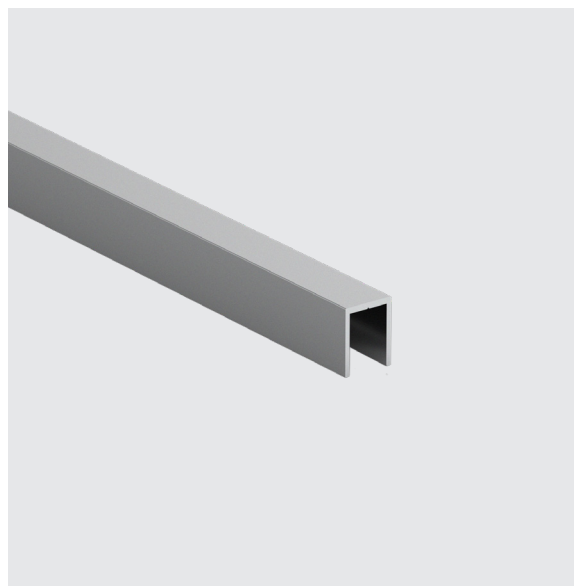
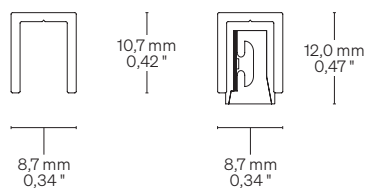

TOCSB

Steel clips → Use for furniture with curved lines
Clip in acciaio → Utilizzare per arredi con linee curve

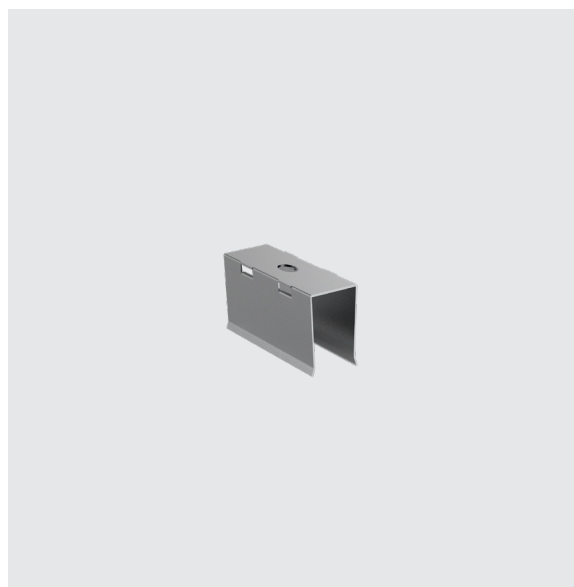
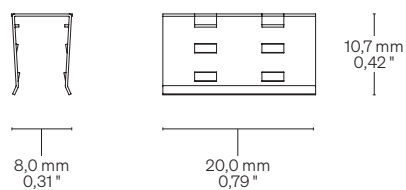

TOUSBF

Flexible Steel Profile
Profilo in Acciaio Flessibile

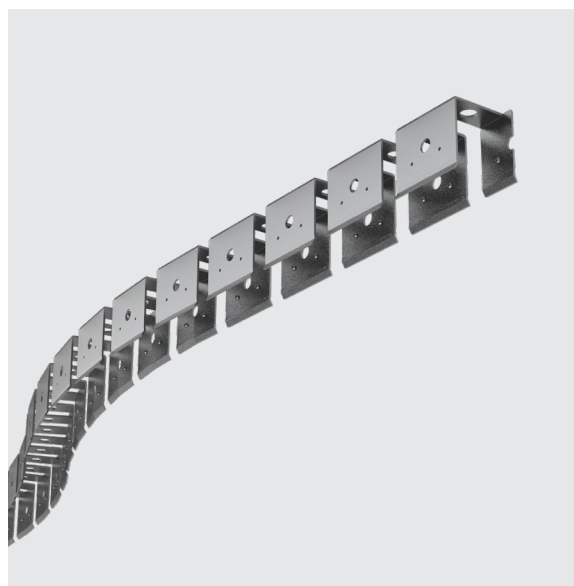
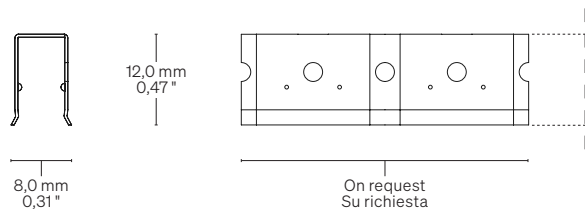

TOOL Side Bend

Code for customised order Codice per ordine su misura	
	
Basic codes Codici base	TOSBF14014 TOOL Side Bend 140 LED/m • 43 LED/ft 14,4 W/m • 4,4 W/ft
CCT K CCT K	<ul style="list-style-type: none"> WW27 ● 2700 K WW30 ● 3000 K NW35 ● 3500 K NW ● 4000 K TW ● 2200 - 5700 K
Cable outlet Uscita cavo	<ul style="list-style-type: none"> A A → Front/Frontale T T → Top/Superiore B B → Bottom/Inferiore F F → Side Front/Lato frontale L L → Side LED/Lato LED
Fastening options Opzioni di fissaggio	<ul style="list-style-type: none"> TOCSB Steel clips Clip in acciaio TOUSB U metal trim Profilo metallico U TOUSBF Flexible Steel Profile Profilo in Acciaio Flessibile
Order length Lunghezza ordinabile	-- Specify the size Specificare la misura
Order example Esempio ordine	<p>TOSBF14014 WW27 A TOCSB • 0,32</p> <p>TOOL Side Bend, 140 LED/m • 43 LED/ft, 14,4 W/m • 4,4 W/ft, Warm White 2700, Front side cable outlet, Steel clips • 0,32 m</p> <p>TOOL Side Bend, 140 LED/m, 14,4 W/m, Warm White 2700, Uscita cavo lato frontale, Clip in acciaio • 0,32 m</p>

Code for coil Codice ordine per bobina	
	
Basic codes Codici base	RTOSBF14014 TOOL Side Bend Coil/Bobina 10 m • 32,8 ft 140 LED/m • 43 LED/ft 14,4 W/m • 4,4 W/ft
CCT K CCT K	<ul style="list-style-type: none"> WW27 ● 2700 K WW30 ● 3000 K NW35 ● 3500 K NW ● 4000 K TW ● 2200 - 5700 K
Cable outlet Uscita cavo	<ul style="list-style-type: none"> A A → Front/Frontale T T → Top/Superiore B B → Bottom/Inferiore F F → Side Front/Lato frontale L L → Side LED/Lato LED
Fastening options Opzioni di fissaggio	<ul style="list-style-type: none"> TOCSB Steel clips Clip in acciaio TOUSB U metal trim Profilo metallico U TOUSBF Flexible Steel Profile Profilo in Acciaio Flessibile
Order example Esempio ordine	<p>RTOSBF14014 WW27 A TOCSB</p> <p>TOOL Side Bend Coil 10 m • 32,8 ft, 140 LED/m • 43 LED/ft, 14,4 W/m • 4,4 W/ft, Warm White 2700, Front side cable outlet, Steel clips</p> <p>TOOL Side Bend Bobina 10 m, 140 LED/m, 14,4 W/m, Warm White 2700, Uscita cavo lato frontale, Clip in acciaio</p>

Warnings Avvertenze

The installation of the product, must be done as illustrated in the catalogue or inside the technical data-sheet that can be asked to the manufacturer.

An installation performed differently from the one indicated may compromise the durability and characteristics of the product itself.

An installation performed differently from the one indicated may compromise the durability and characteristics of the product.

Unsuitable cross-section / length of the cable can negatively affect the lighting power of the product. If Power supplies, even those with a plastic case, are located in spaces that are too small for their dimensions; they will be subjected to dissipation problems that will compromise their functionality. Silicones or resins subjected to temperature changes and used near the product, if not in accordance with the specifications issued by the manufacturer, they can seriously damage the LED component. The products can not be modified without any authorization by the manufacturer.

L'installazione del prodotto, dovrà eseguirsi come illustrato nel catalogo o nella documentazione tecnica richiedibile al produttore. Un'installazione eseguita diversamente da quella indicata, può compromettere la durata e le caratteristiche del prodotto.

Prima dell'installazione verificare la corretta sezione del cavo collegato tra LED e alimentatore.

Sezione / lunghezza del cavo non congrui, possono alterare in negativo la luminosità del prodotto. Gli alimentatori, anche quelli con contenitore plastico, inseriti in spazi troppo piccoli, saranno soggetti a problemi di dissipazione che comprometteranno la loro funzionalità. Siliconi o resine soggetti a sbalzi di temperature e utilizzati in prossimità del prodotto, se non conformi alle specifiche rilasciate dal produttore possono danneggiare gravemente il componente LED. I prodotti non possono essere modificati senza autorizzazione da parte del produttore.