

TOOL Side Bend

140 LED/m • 43 LED/ft
14,4 W/m • 4,4 W/ft

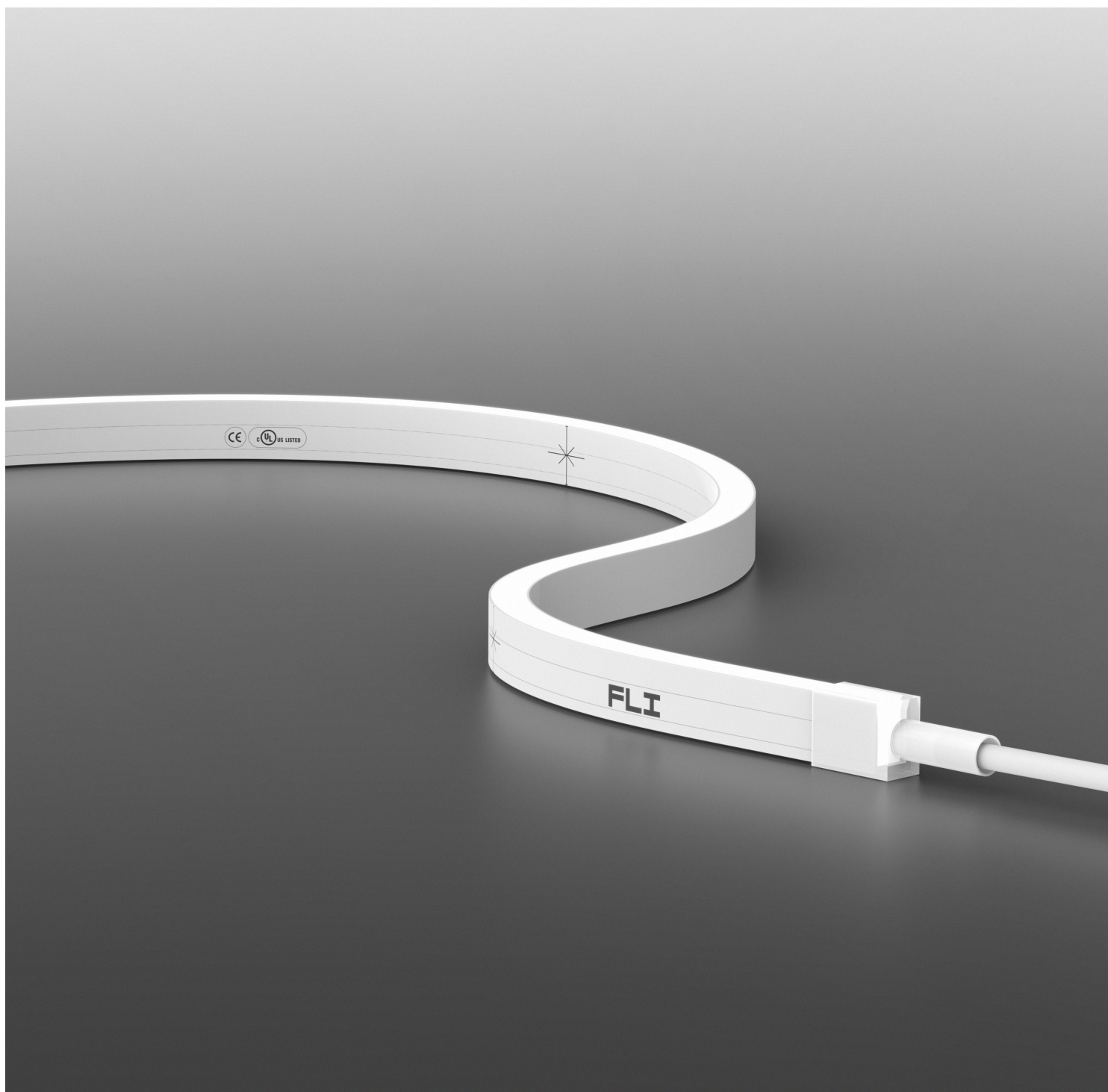

6,5 × 11,0 mm
0,26 × 0,43 "



TOOL Side Bend

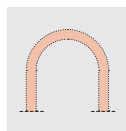

Horizontal Bending

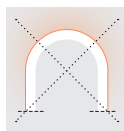

Vertical Bending

Body Corpo

Flexible Strip LED Side Bend

Strip LED flessibile Side Bend

Fastening Fissaggio	Steel clips U aluminium trim Flexible Steel Profile	Clip in acciaio Profilo in alluminio U Profilo in Acc. Fles.
-------------------------------	---	--

Screen Schermo	Silicone rubber	Gomma siliconica
--------------------------	-----------------	------------------

Custom size Lunghezza ordinabile	→ 10 m • 32,8 ft reel with power cables at both ends / Bobina 10 m con cavi di alimentazione in entrambe le estremità → Custom size (Up to 5 m • 16,40 ft with one power supply) / Lunghezza custom (Fino a 5 m con unica alimentazione)	
--	---	--

Finishing Finitura	<input type="radio"/> White	<input type="radio"/> Bianca
------------------------------	-----------------------------	------------------------------

Listings and marks

Certificazioni e marchi



Light Luce

Light source Sorgente luminosa	140 LED/m • 43 LED/ft
--	-----------------------

Power consumption Consumo energia	14,4 W/m • 4,4 W/ft
---	---------------------

CCT K	<input type="radio"/> 2700 K <input type="radio"/> 3000 K <input type="radio"/> 3500 K <input type="radio"/> 4000 K
--------------	--

CRI R9	Min 90 Min 70
-------------------------	------------------

Delivered lumen output Flusso luminoso emesso	44 lm/W 618 lm/m • 188 lm/ft <input type="radio"/> 3000 K
---	---

Input voltage Tensione di ingresso	24 V DC
--	---------

TOOL Side Bend

Dimensions Dimensioni

Scale/Scala 1:1

A → Straight
A → Dritta

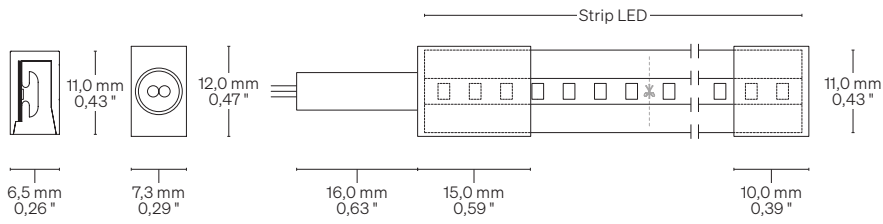

T → Top
T → Superiore

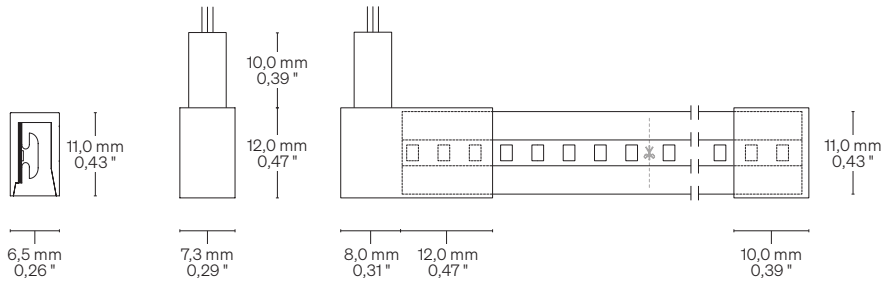

B → Bottom
B → Inferiore

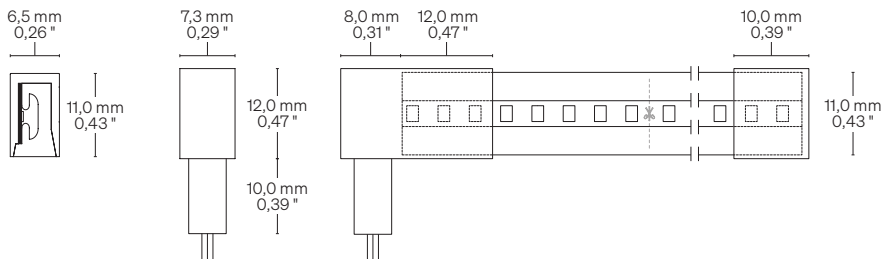

F → Side Front
F → Lato Frontale

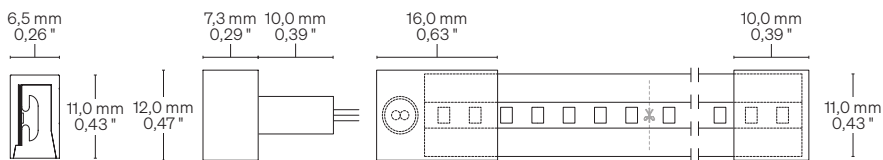

L → Side LED
L → Lato LED

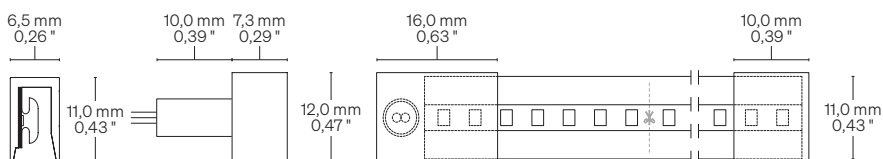

Cable outlet Uscita Cavi

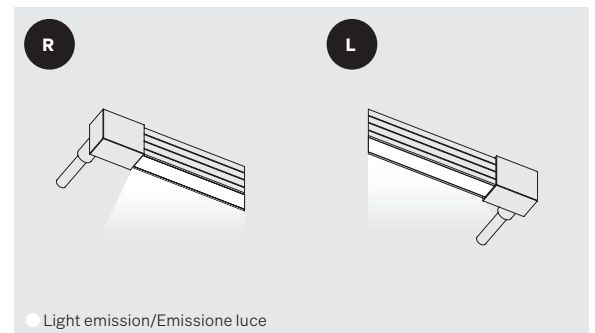
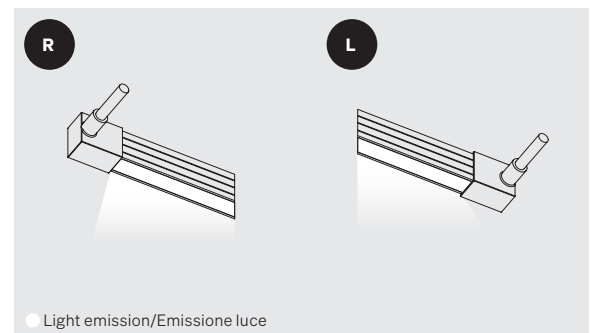
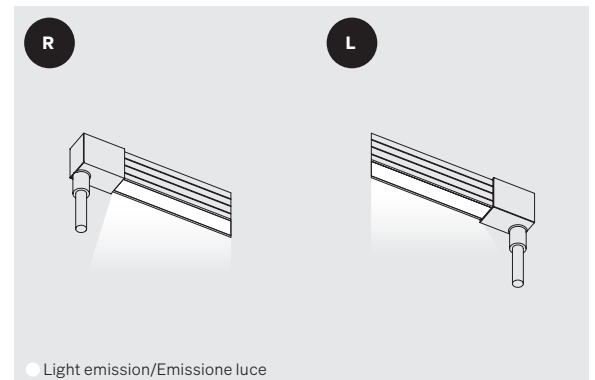
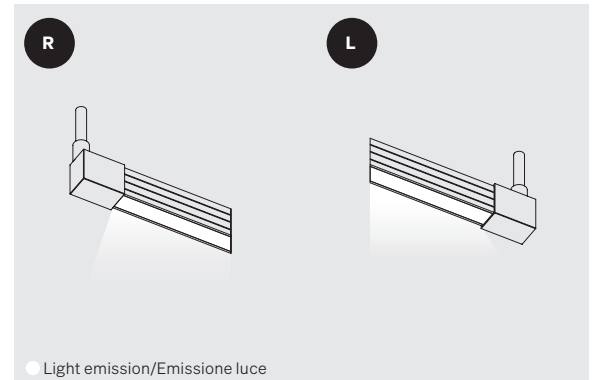
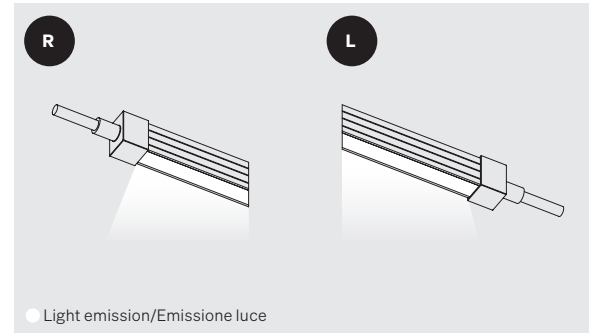

TOOL Side Bend

Cutting point information Informazioni segno di taglio

Scale/Scala 1:1

- 1** Up to 5 m • 16,40 ft with one power supply
Fino a 5 m con unica alimentazione

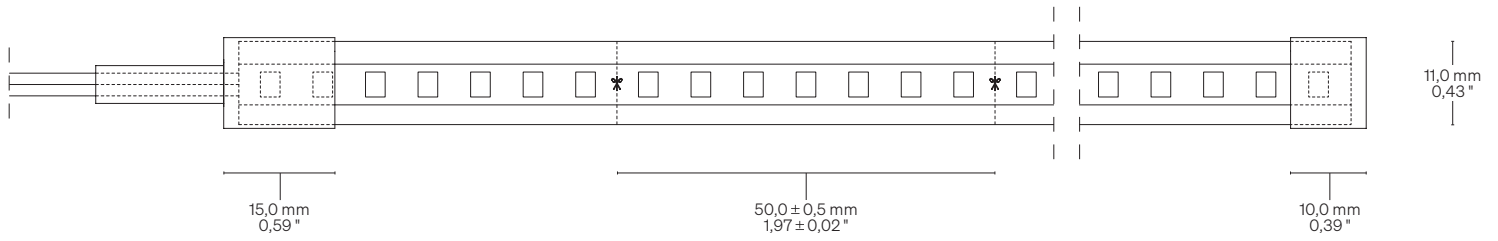

- 2** From 5 to 10 m • From 16,40 to 32,80 ft with dual power supply
Da 5 a 10 m con doppia alimentazione

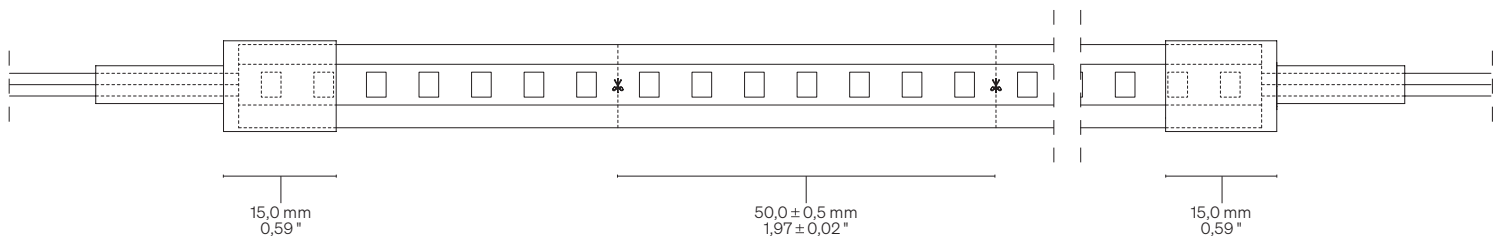

Curvature radius Raggio di curvatura

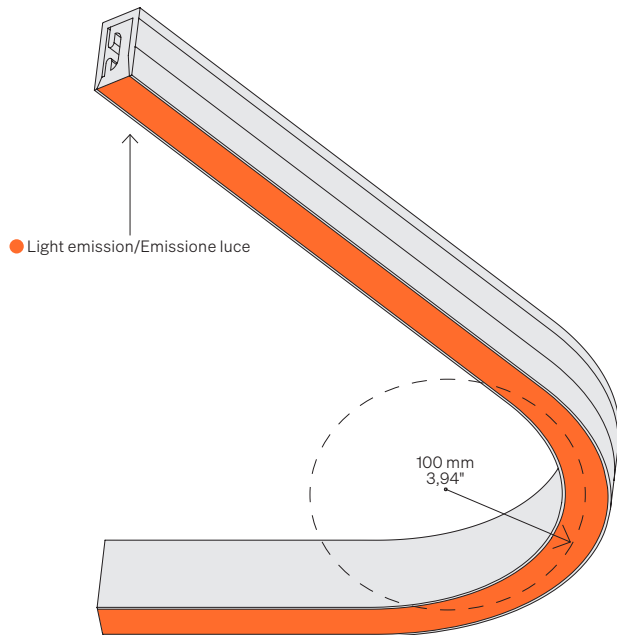

Direction of bending Senso di curvatura

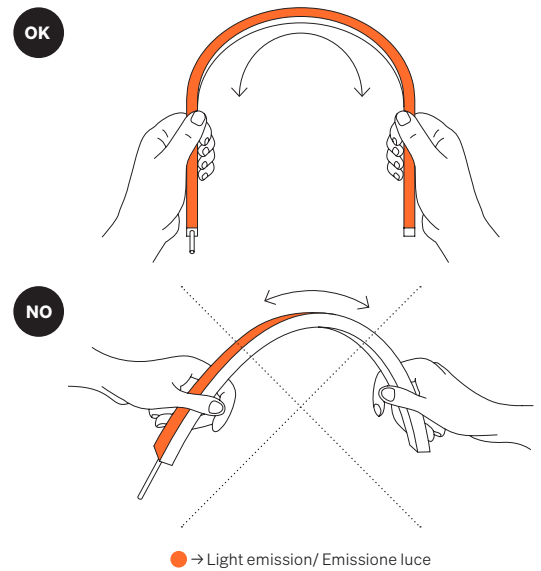

TOOL Side Bend

Fastening options Opzioni di fissaggio

Scale/Scala 1:1

TOCSB

Steel clips
Clip in acciaio

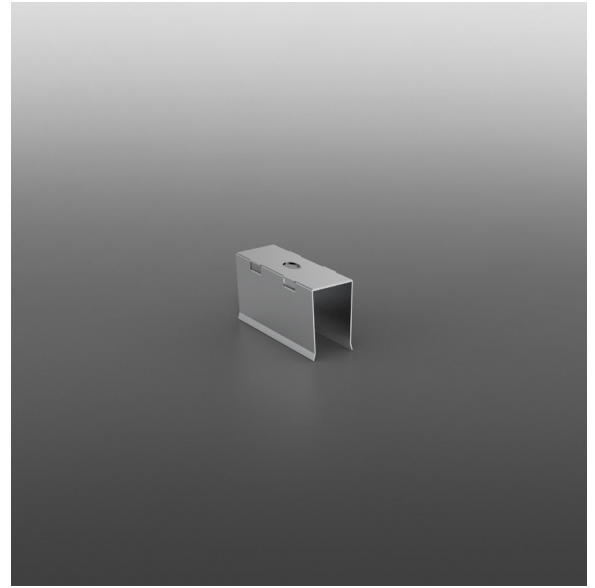
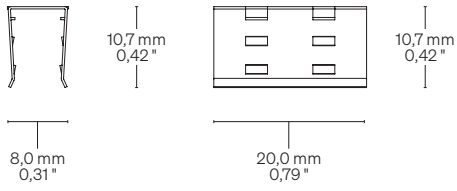

TOUSB3

U aluminium trim
Profilo in alluminio U

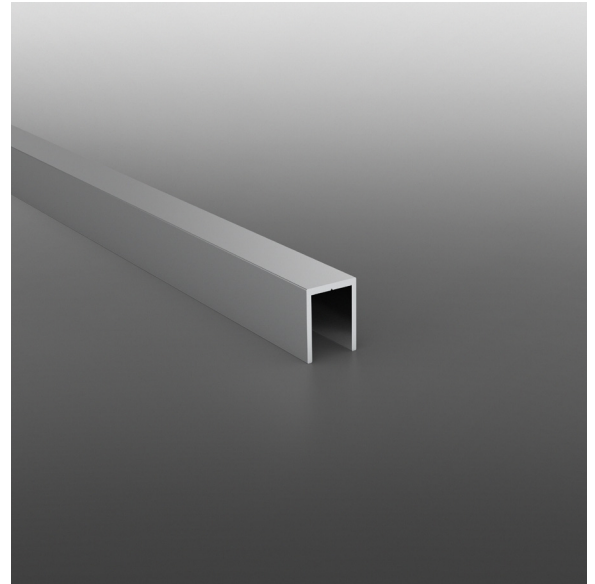
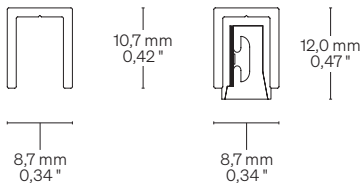

TOUSBF

Flexible Steel Profile
Profilo in Acciaio Flessibile

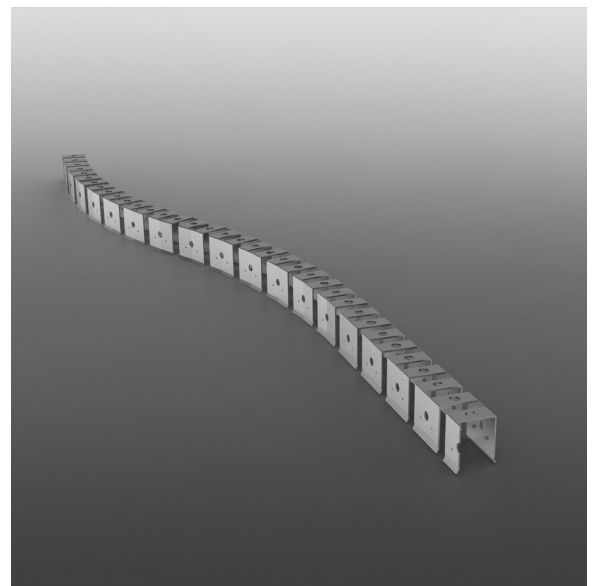
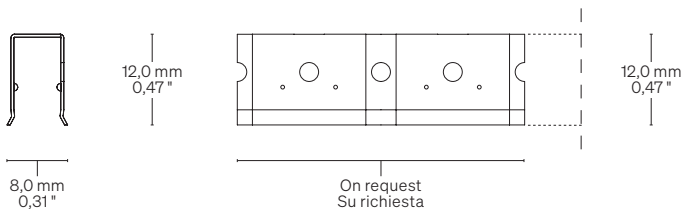

TOOL Side Bend

Code for customised order Codice per ordine su misura



Basic codes Codici base	TOSB14014	TOOL Side Bend 140 LED/m • 43 LED/ft 14,4 W/m • 4,4 W/ft
CCT K CCT K	27 30 35 40	● 2700 K ● 3000 K ● 3500 K ● 4000 K
Cable outlet Uscita cavo	A T B F L	A → Straight/Dritta T → Top/Superiore B → Bottom/Inferiore F → Side Front/Lato frontale L → Side LED/Lato LED
Order length Lunghezza ordinabile	--	Specify the size Specificare la misura

Order example Esempio ordine	TOSB14014 27 A • 0,32	TOOL Side Bend, 140 LED/m • 43 LED/ft, 14,4 W/m • 4,4 W/ft, Warm White 2700, Straight cable outlet • 0,32 m TOOL Side Bend, 140 LED/m, 14,4 W/m, Warm White 2700, Uscita cavo dritta • 0,32 m
--	------------------------------	--

Fastening Fissaggio

Fastening options Opzioni di fissaggio	TOCSB TOUSB3 TOUSBF	Steel clips Clip in acciaio U aluminium trim (3 m • 9,84 ft) Profilo in alluminio a U (3 m) Flexible steel profile, cuttable every 1 m • 3,28 ft, max length: 100 m • 328 ft Profilo in acciaio flessibile, tagliabile ogni 1 m, lunghezza massima: 100 m
--	--	--

Code for coil Codice ordine per bobina



Basic codes Codici base	R10TOSB 14014	TOOL Side Bend Coil/Bobina 10 m • 32,8 ft 140 LED/m • 43 LED/ft 14,4 W/m • 4,4 W/ft 2 × Straight cable outlet/ 2 × Uscita cavo dritta
CCT K CCT K	27 30 35 40	● 2700 K ● 3000 K ● 3500 K ● 4000 K

Order example Esempio ordine	R10TOSB14014 27	TOOL Side Bend Coil 10 m • 32,8 ft, 140 LED/m • 43 LED/ft, 14,4 W/m • 4,4 W/ft, 2 × Straight cable outlet, Warm White 2700 TOOL Side Bend Bobina 10 m, 140 LED/m, 14,4 W/m, 2 × Uscita cavo dritta, Warm White 2700
--	------------------------	--

Fastening and cable outlet caps Fissaggio e tappi uscita cavo

Fastening options Opzioni di fissaggio	K10TOCSB TOUSB3 TOUSBF	Steel clips (10 units) Clip in acciaio (10 unità) U alum. trim (3 m • 9,84 ft) Profilo in alluminio a U (3 m) Flexible steel profile, cuttable every 1 m • 3,28 ft, max length: 100 m • 328 ft Profilo in acciaio flessibile, tagliabile ogni 1 m, lunghezza massima: 100 m
Cable outlet caps Tappi uscita cavo	K10TOSBFCA K10TOSBFCTB K10TOSBFCL	Straight (10 units) Dritta (10 unità) Top/Bottom (10 units) Superiore/Inferiore (10 unità) Side Front/Side LED (10 units) Lato Frontale/Lato LED (10 unità)
End caps Tappi di chiusura	K10TOSBEC	End caps (10 units) Tappi di chiusura (10 unità)

Warnings Avvertenze

The installation of the product, must be done as illustrated in the catalogue or inside the technical data-sheet that can be asked to the manufacturer. An installation performed differently from the one indicated may compromise the durability and characteristics of the product itself.

An installation performed differently from the one indicated may compromise the durability and characteristics of the product. Unsuitable cross-section / length of the cable can negatively affect the lighting power of the product. If Power supplies, even those with a plastic case, are located in spaces that are too small for their dimensions; they will be subjected to dissipation problems that will compromise their functionality. Silicones or resins subjected to temperature changes and used near the product, if not in accordance with the specifications issued by the manufacturer, they can seriously damage the LED component. The products can not be modified without any authorization by the manufacturer.

L'installazione del prodotto, dovrà eseguirsi come illustrato nel catalogo o nella documentazione tecnica richiedibile al produttore. Un'installazione eseguita diversamente da quella indicata, può compromettere la durata e le caratteristiche del prodotto.

Prima dell'installazione verificare la corretta sezione del cavo collegato tra LED e alimentatore. Sezione / lunghezza del cavo non congrui, possono alterare in negativo la luminosità del prodotto. Gli alimentatori, anche quelli con contenitore plastico, inseriti in spazi troppo piccoli, saranno soggetti a problemi di dissipazione che comprometteranno la loro funzionalità. Siliconi o resine soggetti a sbalzi di temperature e utilizzati in prossimità del prodotto, se non conformi alle specifiche rilasciate dal produttore possono danneggiare gravemente il componente LED. I prodotti non possono essere modificati senza autorizzazione da parte del produttore.