

TOOL Wallwasher Asy

18,0 W/m • 5,5 W/ft

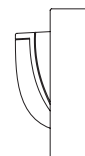

11,5 × 20,0 mm
0,45 × 0,79 "

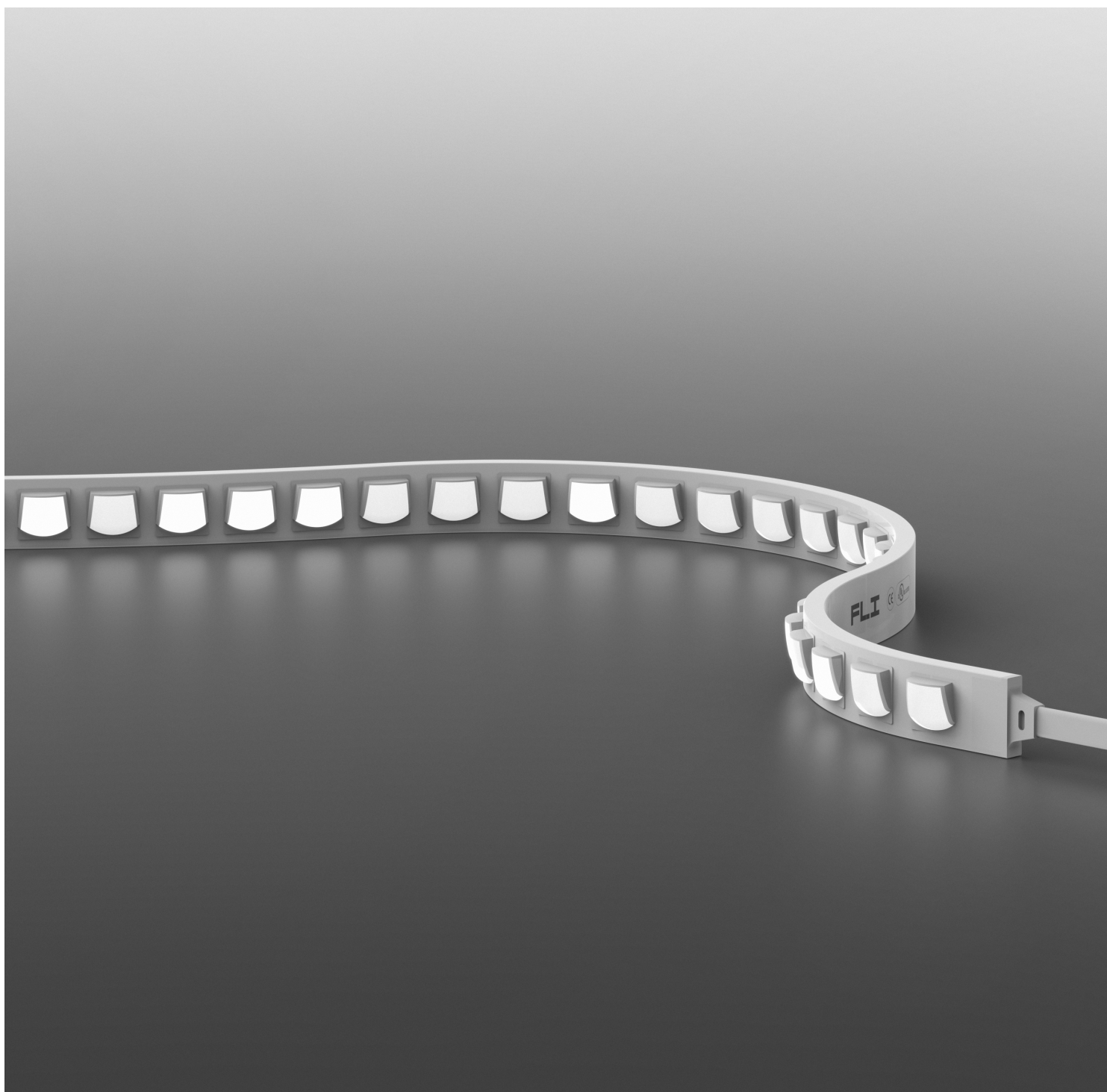

TOOL Wallwasher Asy

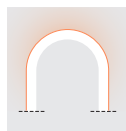
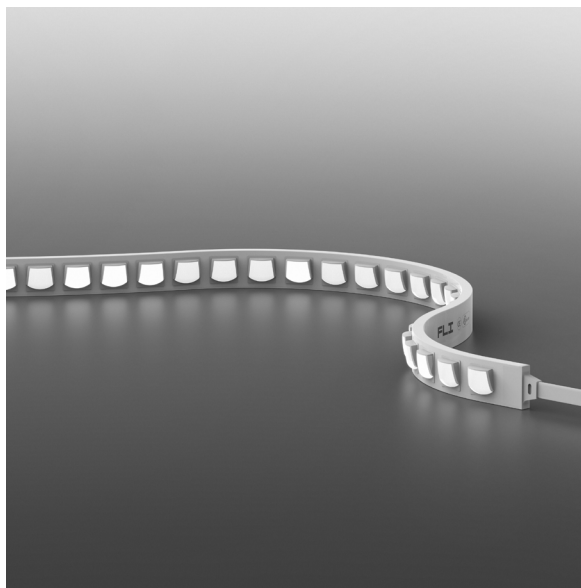

Vertical Bending

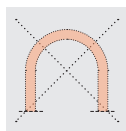

Horizontal Bending

Body Corpo

Flexible Strip LED Wallwasher Asy

Strip LED flessibile Wallwasher Asy

Features Caratteristiche	Consistency One Bin Saltwater Resistant Resistant to Solvents UV Protection Dimmable product	Uniformità LED Res. acqua salata Res. ai solventi Prot. dai raggi UV Prod. dimmerabile
Fastening Fissaggio	Aluminium Mounting clips Aluminium Profile Adjustable clips	Clip di montaggio in alluminio Profilo in alluminio Clip orientabili
Optics Ottiche	OVAL (50°x70°)	OVAL (50°x70°)
Screen Schermo	Silicone rubber	Gomma siliconica
Reel length Lunghezza bobina	→ 5 m • 16,4 ft reel with power cables at both ends / Bobina 5 m con cavi di alimentazione in entrambe le estremità	
Cutting pitch Passo di taglio	166,6 mm • 6,56 "	166,6 mm
Finishing Finitura	○ White	○ Bianca
Max. ambient temperature Temperatura ambiente max.	45 °C	45 °C

Listings and marks
Certificazioni e marchi



Light Luce

Power consumption Consumo energia	18,0 W/m • 5,5 W/ft
CCT K	● 2700 K ● 3000 K ● 4000 K
CRI	≥ 90
Delivered lumen output Flusso luminoso emesso ● 3000 K	88,6 lm/W 1594 lm/m • 486 lm/ft
Max. run length Lunghezza massima	5 m • 16,4 ft
Input voltage Tensione di ingresso	24 V DC

TOOL Wallwasher Asy

Dimensions Dimensioni

Scale/Scala 1:2

Cable outlet Uscita Cavi

Integral Cap (IP67)
Tappo integrato (IP67)

IA → Straight
IA → Dritta

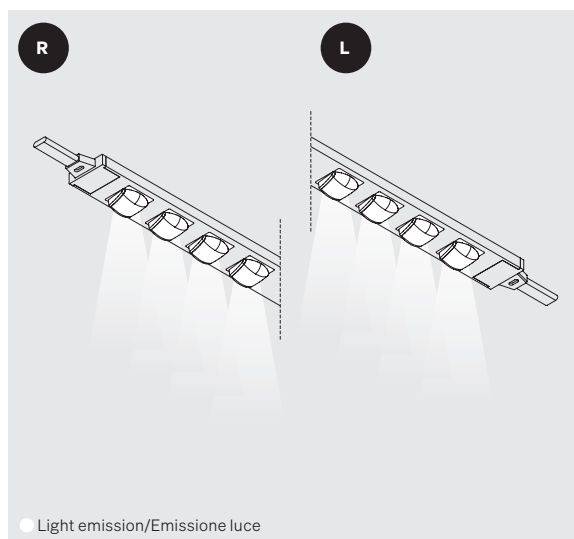
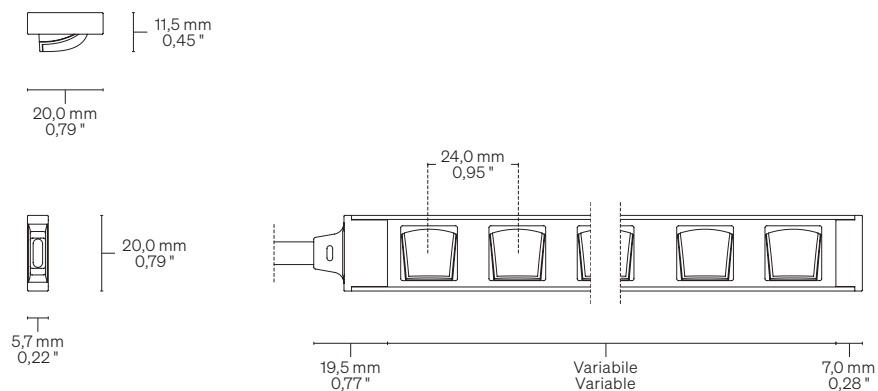

TOOL Wallwasher Asy

Cutting point information Informazioni segno di taglio

Scale/Scala 1:2

- 1 Up to 5 m • 16,40 ft with one power supply
Fino a 5 m con unica alimentazione

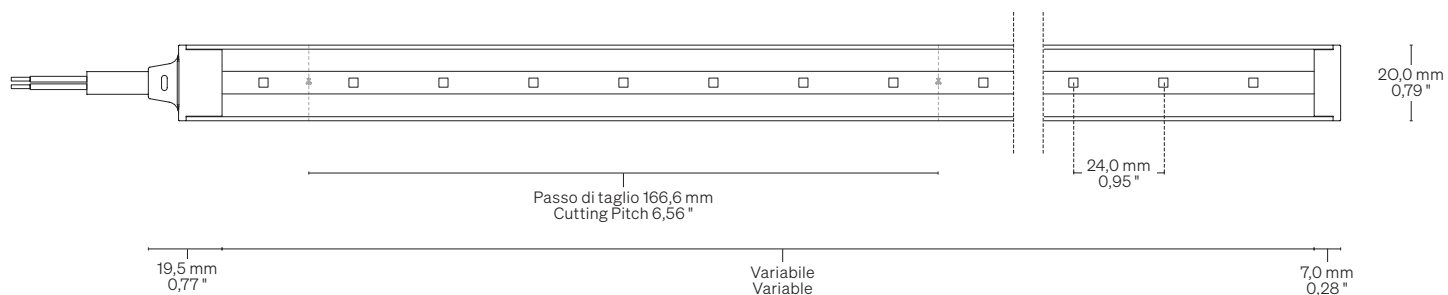

Curvature radius Raggio di curvatura

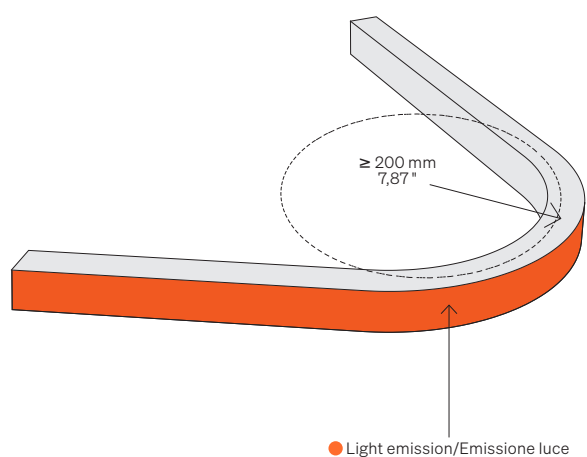

Direction of bending Senso di curvatura

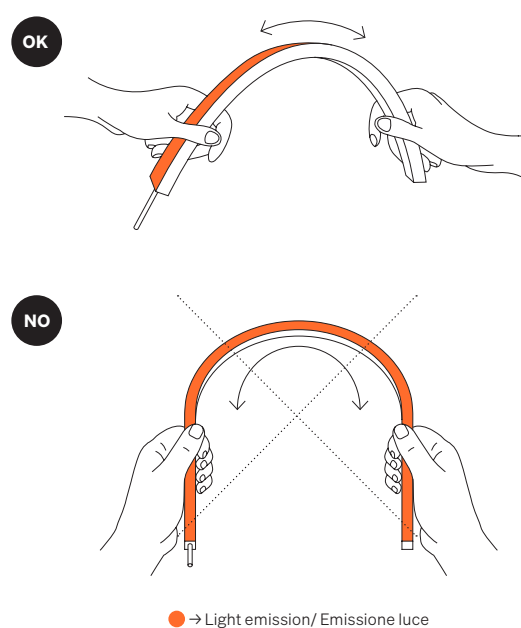

TOOL Wallwasher Asy

Fastening options Opzioni di fissaggio

Scale/Scala 1:1

TOCWWAS

Aluminium Mounting clips → Use for furniture with curved lines
 Clip di montaggio in alluminio → Utilizzare per arredi con linee curve

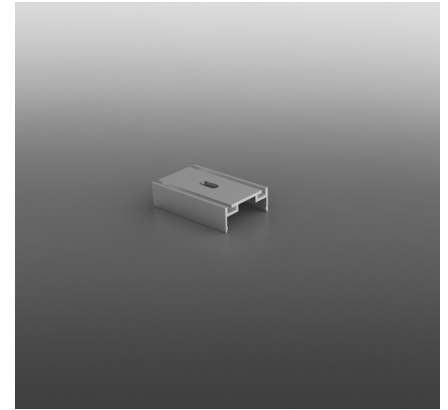
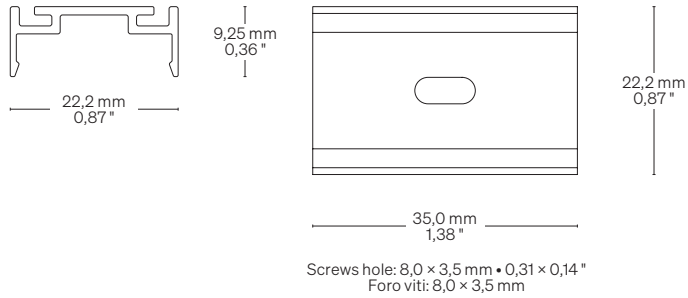

TOUWVAS1

Aluminium profile → Use for furniture with straight lines
 Profilo in alluminio → Utilizzare per arredi con linee dritte

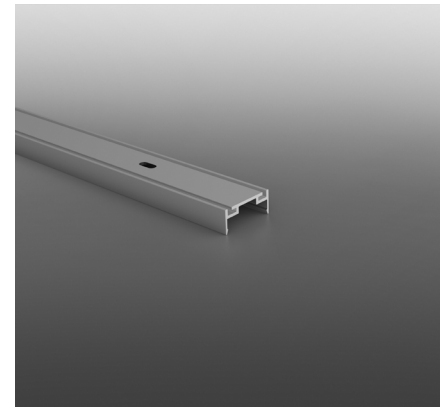
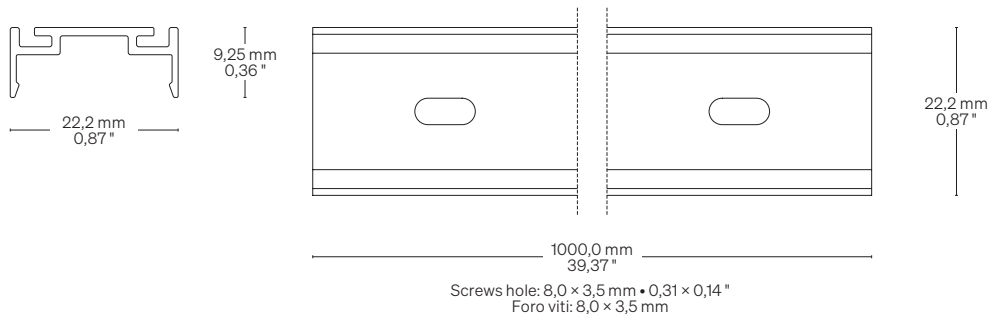

TOACWWAS

Adjustable clips → Use for furniture with curved lines
 Clip orientabili → Utilizzare per arredi con linee curve

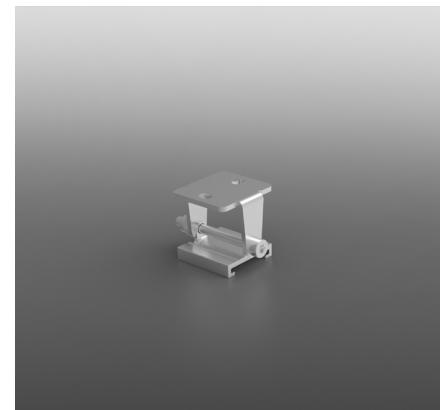
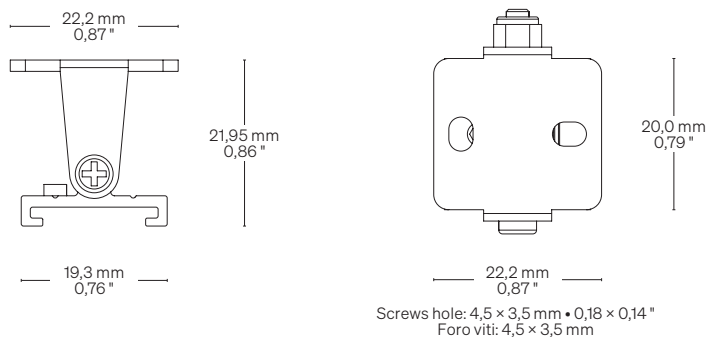

TOOL Wallwasher Asy

Code for customised order Codice per ordine su misura



Basic codes Codici base	• TOWWAS18 TOOL Wallwasher Asy 18,0 W/m • 5,5 W/ft
CCT K CCT K	• 27 ● 2700 K • 30 ● 3000 K • 40 ● 4000 K
Optics Ottiche	• 5070 OVAL (50°×70°)
Cable outlet (Integral cap) Uscita cavo (T. integrato)	• IA Straight/Dritta
Order length Lunghezza ordinabile	• -- Specify the size Specificare la misura

Order example Esempio ordine	• TOWWAS18 27 5070 IA • 0,32 TOOL Wallwasher Asy, 18,0 W/m • 5,5 W/ft, Warm White 2700, OVAL (50°×70°), Integral cap straight cable outlet • 0,32 m TOOL Wallwasher Asy, 18,0 W/m, Warm White 2700, OVAL (50°×70°), Uscita cavo dritta con tappo integrato • 0,32 m
--	--

Fastening Fissaggio

Fastening options Opzioni di fissaggio	• TOCWWAS Aluminium Mounting clips Clip di montaggio in alluminio
	• TOUWWAS1 Aluminium Profile Profilo in alluminio
	• TOACWWAS Adjustable clips Clip orientabili

TOOL Wallwasher Asy

Code for coil Codice ordine per bobina



Basic codes Codici base	<ul style="list-style-type: none"> • R5TOWWAS18 TOOL Wallwasher Asy Coil/Bobina 5 m • 16,4 ft 18,0 W/m • 5,5 W/ft
CCT K CCT K	<ul style="list-style-type: none"> • 27 ● 2700 K • 30 ● 3000 K • 40 ● 4000 K
Optics Ottiche	<ul style="list-style-type: none"> • 5070 OVAL (50°×70°)
Order example Esempio ordine	<ul style="list-style-type: none"> • R5TOWWAS18 27 5070 TOOL Wallwasher Asy Coil 5 m • 16,4 ft, 18,0 W/m • 5,5 W/ft, Warm White 2700, OVAL (50°×70°), Straight cable outlet TOOL Wallwasher Asy Bobina 5 m, 18,0 W/m, Warm White 2700, OVAL (50°×70°), Uscita cavo dritta

Fastening and cable outlet caps Fissaggio e tappi uscita cavo

Fastening options Opzioni di fissaggio	<ul style="list-style-type: none"> • K10TOCWWAS Aluminium Mounting clips Clip di montaggio in alluminio • TOUWWAS1 Aluminium Profile Profilo in alluminio • K10TOACWWAS Adjustable clips Clip orientabili
End caps Tappi di chiusura	<ul style="list-style-type: none"> • K10TOWWASEC End caps Tappi di chiusura

Warnings Avvertenze

The installation of the product, must be done as illustrated in the catalogue or inside the technical data-sheet that can be asked to the manufacturer. An installation performed differently from the one indicated may compromise the durability and characteristics of the product itself.

An installation performed differently from the one indicated may compromise the durability and characteristics of the product. Unsuitable cross-section / length of the cable can negatively affect the lighting power of the product. If Power supplies, even those with a plastic case, are located in spaces that are too small for their dimensions; they will be subjected to dissipation problems that will compromise their functionality. Silicones or resins subjected to temperature changes and used near the product, if not in accordance with the specifications issued by the manufacturer, they can seriously damage the LED component. The products can not be modified without any authorization by the manufacturer.

L'installazione del prodotto, dovrà eseguirsi come illustrato nel catalogo o nella documentazione tecnica richiedibile al produttore. Un'installazione eseguita diversamente da quella indicata, può compromettere la durata e le caratteristiche del prodotto.

Prima dell'installazione verificare la corretta sezione del cavo collegato tra LED e alimentatore. Sezione / lunghezza del cavo non congrui, possono alterare in negativo la luminosità del prodotto. Gli alimentatori, anche quelli con contenitore plastico, inseriti in spazi troppo piccoli, saranno soggetti a problemi di dissipazione che comprometteranno la loro funzionalità. Siliconi o resine soggetti a sbalzi di temperature e utilizzati in prossimità del prodotto, se non conformi alle specifiche rilasciate dal produttore possono danneggiare gravemente il componente LED. I prodotti non possono essere modificati senza autorizzazione da parte del produttore.